

D1EX

Ex db IIC, Ex eb IIC, Ex tb IIIC, Ex nR IIC

CAPTIVE COMPONENT GLAND® for Steel Wire Armoured Cable

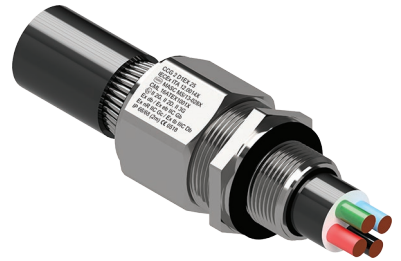

Features and Benefits

- For indoor, Group II, III, Zone 1, 2, 21 and 22 hazardous areas.
- Two part handling, no loose parts.
- Freely rotating captive cone and inspectible cone ring provides an armour clamp and earth bond on steel wire armour.
- Specially formulated captive elastomeric seal for Built-in Safety™, seals on the inner sheath of the cable IP65/66/68.
- Precision manufactured from high-quality brass (Marine Grade Electroless Nickel Plated™).
- Complete with thread sealing gasket.

Technical Data

Type:	D1EX
Gland Material:	Brass (Marine Grade Electroless Nickel Plated™)
Seal Material:	Standard Thermoset Elastomer or Extreme Temperature Seals
Seal Gasket Material:	HDPE, Nylon 66 or PTFE
Cable Type:	Steel Wire Armour
Armour Clamping:	Rotating Captive Cone and Inspectible Cone Ring
Sealing Area:	Inner Sheath
Optional Accessories:	Adaptor, Reducer, Earth Tag, Locknut, Serrated Washer and Shroud
Note:	The installer should ensure that the materials are suitable for the installation environment.

Standards and Certifications

Equipment Protection Levels:	IECEX: Ex db IIC Gb, Ex eb IIC Gb, Ex nR IIC Gc, Ex tb IIIC Db ATEX: Ⓜ II 2GD, II 3G, Ex db IIC Gb, Ex eb IIC Gb, Ex nR IIC Gc TR CU: 1Ex d IIC Gb X / 1Ex e IIC Gb X / 2Ex nR IIC Gc X / Ex tb IIIC Db X	
Continuous Operating Temp:	Standard Seals: -60°C to +95°C/100°C (HDPE/Nylon Sealing Gasket) Extreme Temp. Seals: -60°C to +160°C (PTFE)	
Conformance:	Standard: Certificate:	
IEC/BS EN	IEC/BS EN 62444	CML 14CA364
IECEX	IEC 60079 Parts 0, 1, 7, 15, 31	IEC Ex CML 18.0018X
ATEX	EN 60079 Parts 0, 1, 7, 31 EN 60079 Parts 0, 15	CML 16ATEX1001X CML 16ATEX4002X TÜV 15.0483X
INMETRO (Brazil)	ABNT NBR IEC 60079 Parts 0, 1, 7, 15, 31	TÜV 15.0483X
TR CU (Russia)	ГОСТ Р МЗК 60079-0, 7, 15, 31 ГОСТ IEC 60079-1	RU C-ZA-ME92.B.00690
SANS	SANS 60079 Parts 0, 1, 7, 15, 31	MASC MS/13-028X CML 15Y728
IP66/68 100m - Parallel	IEC 60529	
IP65/66 - Tapered	IEC 60529	
EMC Compatible	EN 55011:2009 + A1:2010, EN 55022:2010	SGS EMC197708/1

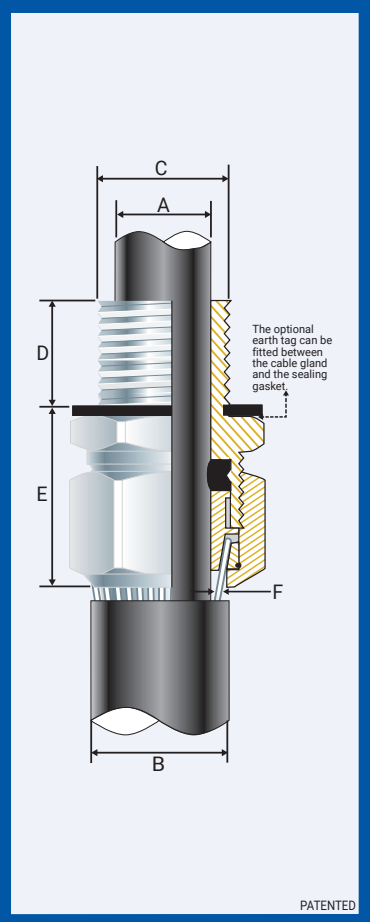

Conditions for Safe Use - X

- The cable glands shall only be used where the temperature, at the point of entry, is between -60°C and +95°C (standard seal & HDPE sealing gasket), +100°C (standard seal and Nylon sealing gasket) or +160°C (extreme temp. seal & PTFE sealing gasket) depending on seal and gasket used.
- According to IEC 60079-14, 10.6.2: An Ex d gland will only maintain Ex d integrity when used with substantially round, compact and filled cable. If not a CCG QuickStop-Ex® barrier gland should be used.

Product Code	Gland Size Reference	Metric Entry Thread		NPT Entry Thread		Cable Detail			Maximum Length 'E'	Armour Dia		Hexagonal Detail		Installation Torque Value Nm
		'C'	Min 'D'	'C'	Min 'D'	Min 'A'	Max 'A'	Max 'B'		Min 'F'	Max 'F'	Max 'Flats'	Max 'Crns'	
051900-16	*00-16ss	M16x1.5	15	-	-	3.0	8.5	13.5	53.0	0.20	0.90	24.0	27.0	21.0
051900	*00-20ss	M20x1.5	15	1/2/3/4	15	3.0	8.5	13.5	53.0	0.20	0.90	24.0	27.0	21.0
0519-0	*0-20s	M20x1.5	15	1/2/3/4	15	7.0	12.0	16.0	53.0	0.20	1.25	24.0	27.0	21.0
051901	*1-20	M20x1.5	15	1/2/3/4	15	9.0	15.0	20.5	56.0	0.20	1.25	27.0	30.0	21.0
051922	*2s-25s	M25x1.5	15	3/4/1	15/19	11.0	17.5	24.5	60.0	0.20	1.60	35.0	39.0	30.0
051902	*2-25	M25x1.5	15	3/4/1	15/19	14.0	20.0	26.5	60.0	0.20	1.60	35.0	39.0	30.0
051933	*3s-32s	M32x1.5	15	1/1 1/4	19	15.0	22.0	30.5	66.0	0.20	2.00	42.0	47.0	42.0
051903	*3-32	M32x1.5	15	1/1 1/4	19	19.0	26.5	33.5	66.0	0.20	2.00	42.0	47.0	42.0
051944	4s-40s	M40x1.5	15	1 1/4/1 1/2	19/21	22.0	31.5	39.5	78.0	0.30	2.00	52.0	59.0	52.0
051904	4-40	M40x1.5	15	1 1/4/1 1/2	19/21	26.0	34.0	42.5	78.0	0.30	2.00	52.0	59.0	52.0
051955	5s-50s	M50x1.5	15	1 1/2/2	21	29.0	38.0	47.5	87.0	0.40	2.50	65.0	73.0	57.0
051905	5-50	M50x1.5	15	1 1/2/2	21	34.0	44.5	52.5	87.0	0.40	2.50	65.0	73.0	57.0
051966	6s-63s	M63x1.5	15	2/2 1/2	21/30	38.0	50.0	60.5	110.0	0.40	2.50	80.0	90.0	66.0
051906	6-63	M63x1.5	15	2/2 1/2	21/30	44.0	56.5	65.5	110.0	0.40	2.50	80.0	90.0	66.0
051977	7s-75s	M75x1.5	15	2 1/2/3	30/32	50.0	62.0	72.5	118.0	0.40	3.15	96.0	108.0	72.0
051907	7-75	M75x1.5	15	2 1/2/3	30/32	56.0	67.5	78.0	118.0	0.40	3.15	96.0	108.0	72.0
051908	8-80	M80x2.0	20	-	-	59.0	69.0	77.5	175.0	2.50	3.15	96.0	108.0	80.0
051999	9s-90s	M90x2.0	20	-	-	66.0	75.0	86.5	184.0	3.00	3.50	111.0	125.0	89.0
051909	9-90	M90x2.0	20	-	-	74.0	81.5	91.0	184.0	3.00	3.50	111.0	125.0	89.0
051910	10-100	M100x2.0	20	-	-	81.0	91.0	100.0	189.0	3.00	3.50	125.0	141.0	89.0
051911	11-115	M115x2.0	20	-	-	86.0	98.0	114.0	189.0	3.00	4.00	135.0	152.0	175.0
051912	12-120	M120x2.0	20	-	-	95.0	103.0	118.0	189.0	3.00	4.00	140.0	158.0	175.0
051913	13-130	M130x2.0	20	-	-	100.0	115.0	124.0	189.0	3.00	4.00	146.0	164.0	175.0

All dimensions except NPT are in mm. * For use with CCG Posi Fit Boxes. Intermediate thread sizes are available on request.

CCG reserves the right to make alterations to the technical data, dimensions, designs and products available without notice. The illustrations cannot be considered binding. Please contact CCG for assistance.

D1EX-GH100619

D1EX GLAND Ex db IIC, Ex eb IIC, Ex tb IIIC, Ex nR IIC

ENCLOSURES AND EQUIPMENT TO WHICH CABLE GLANDS ARE FITTED:-

- Must be made from materials which are compatible with the cable gland materials.
- Have a sealing area around the cable gland entry point with a surface roughness <math>< Ra 6.3 \mu m</math>.
- Have entries that are perpendicular to the enclosure face in the area where the cable gland will seal to within 2.5°.
- Are sealed using the supplied sealing gasket (parallel threads) or by fully tightening into a threaded entry (tapered threads). Note that for tapered threads the IP rating can be improved to IP68 with the use of a suitable thread sealant.

MUST HAVE THREADED ENTRIES

- The same thread size as the cable gland. (Thread adapters should be used to correct

any mismatch).

- With a thread tolerance of metric class '6H' or equivalent.
- Where the thread length is a minimum of 10mm for Ex d applications or 3mm for all other applications

OR CLEARANCE HOLES (not Ex d)

- Where the hole size is the thread nominal size with a tolerance of +0.1 to +0.7mm. (e.g. the clearance hole for an M20 thread will have a diameter between 20.1mm and 20.7mm).
- Through material that is between 1mm and 12mm thick. (Thicker materials can be accommodated using glands with extended entry threads.)

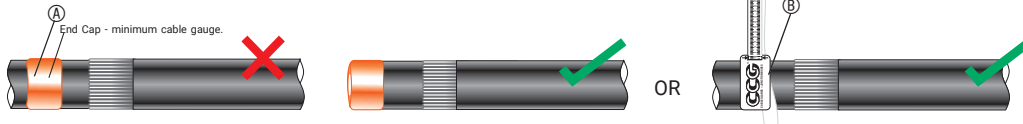

1. Check the correct gland size using an end cap (patented) (A). If the cable sheath passes through the hole in the end cap (A), use a gland one size smaller. For accurate sizing, use a CCG Dimension Tape (B) on the cable sheath.

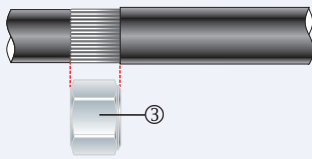

2. Cut back the cable outer sheath to expose the armour to a length not more than the outer (3).

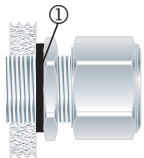

3. To maintain IP66/68 ensure the gasket (1) is in place.

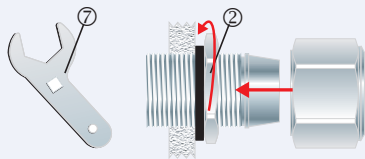

4. Screw the inner (2) into the apparatus and tighten to the installation torque using a CCG Spanner (7).

Alternative installation through an unthreaded entry.

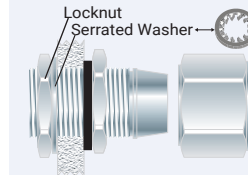

If the apparatus is untapped use a locknut.

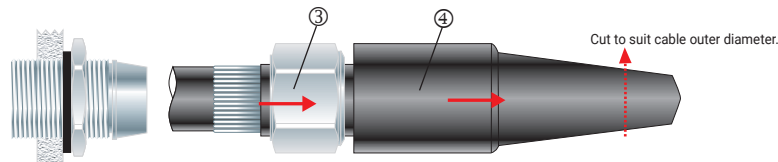

5. Cut the shroud (4) to suit the cable outer diameter. Pass the shroud (4) and the outer (3) over the cable.

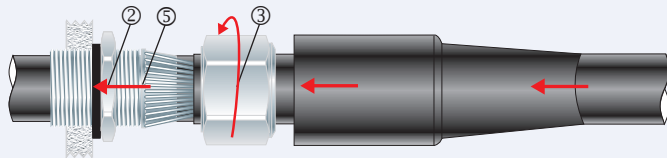

6. Pass the cable end through the inner (2). Splay the armour wires over the cone (5). Tighten the outer (3) onto the inner (2) to lock the armour between the cone (5) and the cone ring (6).

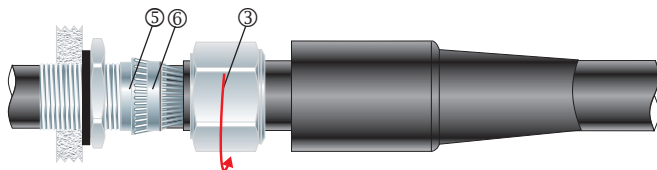

7. Unscrew the outer (3). Check that the armour has locked between the cone (5) and cone ring (6). (O-Ring on the cone ring (6) is sacrificial).

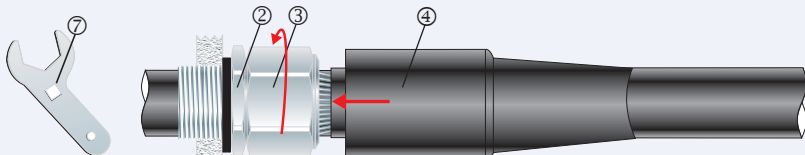

8. Tighten the outer (3) onto the inner (2) to the installation torque using a CCG Spanner (7). Slide the shroud (4) over the gland.