

ARMORTEX™

Ex db I/IIC, Ex eb I/IIC, Ex ta IIIC, Ex nR IIC

CAPTIVE COMPONENT GLAND® for Multi Armoured Cable



Features and Benefits

- For Group I underground mines, Group II, III, Zone 1, 2, 21 and 22 hazardous areas.
- Freely rotating multi armour captive cone and inspectible cone ring provides an armour clamp and earth bond on braid, tape or steel wire armour.
- Armour clamp components can be inspected after installation.
- Factory fitted with a specially formulated elastomeric seal provides Built-in Safety™.
- Precision manufactured from high-quality brass (Marine Grade Electroless Nickel Plated™) available in stainless steel 316/316L on request.
- Supplied with a thread sealing gasket (parallel threads only).



Technical Data

Type:	ARMORTEX™
Gland Material:	Brass (Marine Grade Electroless Nickel Plated™), Stainless Steel 316/316L
Seal Material:	Standard Thermoset Elastomer or Extreme Temperature Seals
Sealing Gasket Material:	HDPE, Nylon 66 or PTFE
Cable Type:	Steel Wire, Braid, Tape and Aluminium Armour
Armour Clamping:	Rotating Multi Armour Cone and Inspectible Cone Ring
Sealing Area:	Inner Sheath and Outer Sheath
Optional Accessories:	Adaptor, Earth Tag, Locknut, Reducer, Serrated Washer and Shroud
Note:	The installer should ensure that the materials are suitable for the installation environment.

Standards and Certifications

Equipment Protection Levels: IECEx/INMETRO: Ex d I Mb/ IIC Gb, Ex e I Mb/IIC Gb, Ex nR IIC Gc, Ex ta IIIC Da
ATEX/UKEX: Ⓢ I M2, Ⓢ II 2/3G 1D, Ex db I Mb/ IIC Gb, Ex eb I Mb/IIC Gb, Ex nR IIC Gc, Ex ta IIIC Da
TR CU: Ⓢ 1Ex d IIC Gb X / PB Ex d I Mb X / 1Ex e IIC Gb X / ПП Ex e I Mc X / 2Ex nR IIC Gc X / Ex tb IIIC Db X

Continuous Operating Temp: Standard Seals: -60°C to +95°C/100°C (HDPE/Nylon Sealing Gasket)
Extreme Temp. Seals: -60°C to +160°C (PTFE Sealing Gasket)

Conformance:	Standard:	Certificate:
IEC/BS EN	IEC/BS EN 62444	CML 14CA364
IECEX	IEC 60079 Part 0, 1, 7, 15, 31	IECEX TSA 22.0011X
ATEX	EN 60079 Part 0, 1, 7, 31	CML 16ATEX1001X CML 16ATEX4002X
UKEX	BS EN 60079 Part 0, 1, 7, 31 BS EN 60079 Part 0, 15	CML 21UKEX1011X CML 21UKEX4006X
INMETRO (Brazil)	ABNT NBR IEC 60079 Part 0, 1, 7, 15, 31	TÜV 15.0483X
TR CU (Russia)	ГОСТ 31610-0, 15, ГОСТ IEC 60079-1 ГОСТ Р МЭК 60079-7, 31	EAЭC RU C-ZA.HA91.B.00245/21
SANS	SANS/IEC 60079 Part 0, 1, 7, 15, 31 SANS 808	MASC MS/22-9001X
IP66/68 - Parallel	SANS/IEC 60529	MASC MS/22-9001X
IP65 - Tapered	SANS/IEC 60529	
IP68 - Tapered and approved grease Deluge Protection	IEC 60529 DTS-01	IECEX CML 18.0018X CML 14CA370-2
Corrosion Protection	ASTM B117-11, BS EN ISO 3231	EXOVA N968667
Marine ABS	IEC 60079 Part 0, 1, 7, 15, 31, IEC 60529	ABS 20-1952706-1-PDA
DNV-GL	IEC 60079 Part 0, 1, 7, IEC 60529	DNV-GL TAE0000010
EMC Compatible	EN 55011, + A1, EN 55022	SGS EMC305079/1

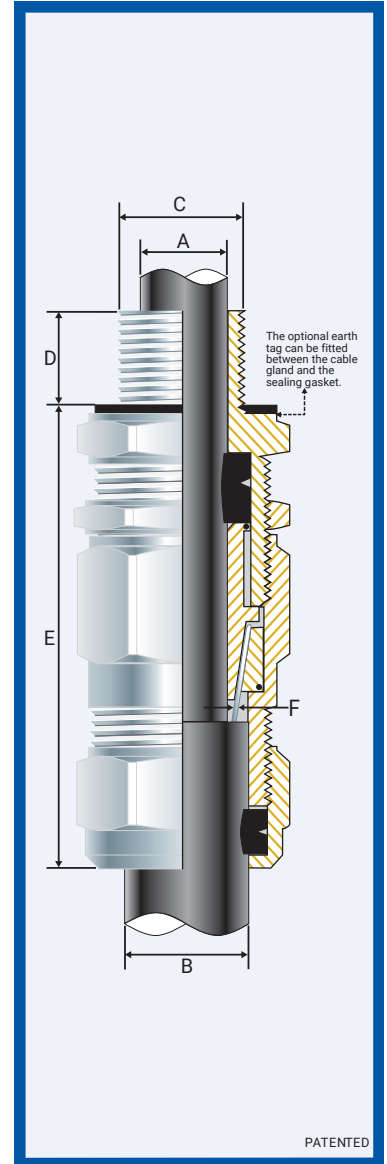

Conditions for Safe Use - X

- The cable glands shall only be used where the temperature, at the point of entry, is between -60°C to +95°C (standard seal & HDPE sealing gasket), -60°C to +100°C (standard seal and Nylon sealing gasket) or -60°C to +160°C (extreme temp. seal & PTFE sealing gasket) depending on seal and gasket used.
- Braided cables are only suitable for Group II or III applications with this gland and the user shall ensure adequate clamping of the cable.
- For unfilled cable use a CCG VORTEX® or QuickStop-Ex® barrier gland should be used.

Product Code	Gland Size Reference	Metric Entry Thread		NPT Entry Thread		Cable Detail				Max Length 'E'	Armour Dia		Hexagonal Detail		Installation Torque Value Nm
		'C'	Min 'D'	'C'	Min 'D'	Min 'A'	Max 'A'	Min 'B'	Max 'B'		Min 'F'	Max 'F'	Max 'Flats'	Max 'Crns'	
052200-16	00-16	M16x1.5	15	-	-	3.0	8.0	8.0	13.5	73.0	0.20	1.25	25.0	28.0	35.0
052200	00-20ss	M20x1.5	15	1/2 3/4	15	3.0	8.0	8.0	13.5	73.0	0.20	1.25	25.0	28.0	35.0
0522-0	0-20s	M20x1.5	15	1/2 3/4	15	8.0	11.5	11.5	16.0	73.0	0.20	1.25	25.0	28.0	35.0
052201	1-20	M20x1.5	15	1/2 3/4	15	11.5	14.0	12.5	19.0	78.0	0.20	1.25	27.0	30.0	35.0
052202	2-25	M25x1.5	15	3/4 1	15/19	14.0	20.2	18.0	26.5	85.0	0.20	1.60	40.0	45.0	50.0
052203	3-32	M32x1.5	15	1 1/4	19	20.0	26.5	23.0	33.0	95.0	0.20	2.00	45.0	51.0	70.0
052204	4-40	M40x1.5	15	1 1/4 1 1/2	19/21	26.5	34.0	28.0	40.5	105.0	0.30	2.00	55.0	62.0	90.0
052255	5s-50s	M50x1.5	15	1 1/2 2	21	32.5	38.0	35.2	46.0	108.0	0.40	2.50	70.0	79.0	100.0
052205	5-50	M50x1.5	15	1 1/2 2	21	38.0	44.5	44.4	52.0	108.0	0.40	2.50	70.0	79.0	100.0
052266	6s-63s	M63x1.5	15	2 2/2	21/30	44.5	50.0	45.5	60.0	145.0	0.40	2.50	85.0	96.0	120.0
052206	6-63	M63x1.5	15	2 2/2	21/30	50.0	56.0	54.6	67.0	145.0	0.40	2.50	85.0	96.0	120.0
052207	7-75	M75x1.5	15	2 1/2 3	30/32	56.0	65.0	59.0	78.0	155.0	0.40	3.15	96.0	108.0	120.0

All dimensions except NPT are in mm. Intermediate thread sizes are available on request. NPT threads should be tightened 'wrench tight'.

CCG reserves the right to make alterations to the technical data, dimensions, designs and products available without notice. The illustrations cannot be considered binding. Please contact CCG for assistance.

ARTX_HMG010622

ARMORTE_x™ GLAND

ENCLOSURES AND EQUIPMENT TO WHICH CABLE GLANDS ARE FITTED:-

- Must be made from materials which are compatible with the cable gland materials.
- Have a sealing area around the cable gland entry point with a surface roughness <math>< Ra 6.3 \mu m.</math>
- Have entries that are perpendicular to the enclosure face in the area where the cable gland will seal to within 2.5°.
- Are sealed using the supplied sealing gasket (parallel threads) or by fully tightening into a threaded entry (tapered threads). Note that for tapered threads the IP rating can be improved to IP68 with the use of a suitable thread sealant.

MUST HAVE THREADED ENTRIES

- The same thread size as the cable gland. (Thread adapters should be used to correct

any mismatch).

- With a thread tolerance of metric class '6H' or equivalent.
- Where the thread length is a minimum of 10mm for Ex d applications or 3mm for all other applications

OR CLEARANCE HOLES (not Ex d)

- Where the hole size is the thread nominal size with a tolerance of +0.1 to +0.7mm. (e.g. the clearance hole for an M20 thread will have a diameter between 20.1mm and 20.7mm).
- Through material that is between 1mm and 12mm thick. (Thicker materials can be accommodated using glands with extended entry threads.)

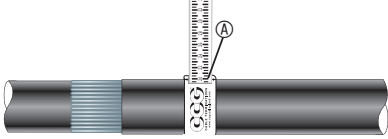

1. For accurate sizing, use a CCG Dimension Tape (A) on the inner and outer cable sheath.

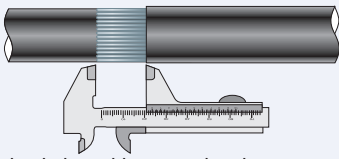

Gland Size	Armour Length	Gland Size	Armour Length	Gland Size	Armour Length	Gland Size	Armour Length
00-16ss	20.0	1-20	20.0	4-40	30.0	6s-63s	45.0
00-20ss	20.0	2-25	25.0	5s-50s	35.0	6-63	45.0
0-20s	20.0	3-32	30.0	5-50	35.0	7-75	50.0

2. Cut back the cable outer sheath to expose the armour to a length as per the table.

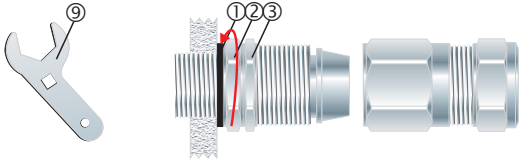

If the gland has NPT entry threads fitted to a threaded entry then IP68 (2m) can be achieved by applying one of the following tested and approved grease types to the thread:- Renolit Lubrene CA700 or LX220 EP2, Renolit LC-WP2 or Moly LX2, or Dow Corning 4 Electrical Compound.

3. To maintain IP66/68, ensure the gasket (1) is in place. Screw the inner (2) into the apparatus. Tighten the inner (2) to the installation torque using a CCG Spanner (9). Ensure the locknut (3) is screwed up against the inner (2).

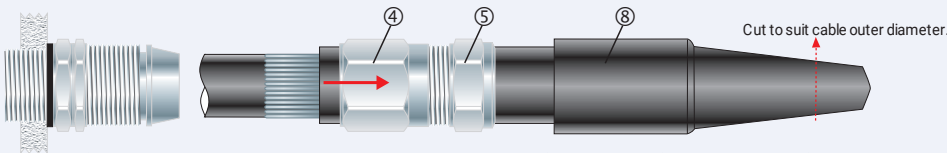

4. Cut the shroud (8) to suit the cable outer diameter. Pass the shroud (8), outer nut (5) and the body (4) over the cable.

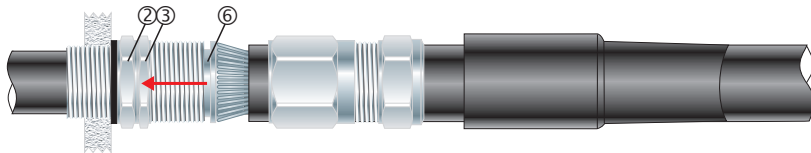

5. Pass cable end through the locknut (3) and inner (2). Splay the armour wires over cone (6).

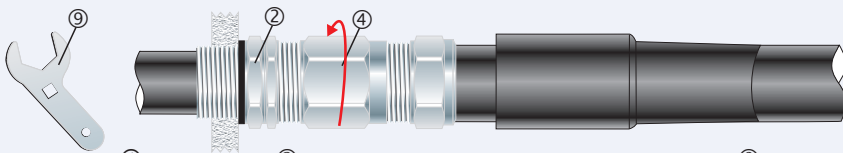

6. Tighten the body (4) onto the inner (2) until hand-tight, then tighten with a CCG Spanner (9) with 3/4 turn to lock the armour between the cone (6) and the cone ring (7).

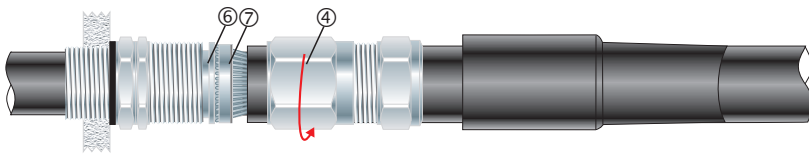

7. Unscrew the body (4). Check that the armour has locked between the cone (6) and cone ring (7). (O-Ring on the cone ring (7) is sacrificial).

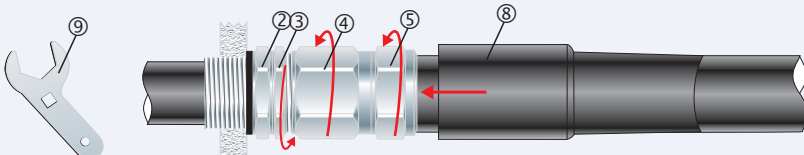

8. Tighten the body (4) onto the inner (2) to the installation torque using a CCG Spanner (9). Tighten the locknut (3) against the body (4) then tighten the outer nut (5) against the body (4) to produce a moisture proof seal, slide the shroud (8) over gland.