

E1EX LEAD SEAL

Ex db IIC, Ex eb IIC, Ex tb IIIC, Ex nR IIC

CABLE GLAND for Lead Sheathed Armoured Cable



Features and Benefits

- For use indoors, outdoors Group II, III, Zone 1, 2, 21 and 22 hazardous areas.
- Two-part handling, no loose parts.
- Provides 360° earthing to lead sheath.
- Freely rotating captive cone ring, providing an armour clamp and earth bond without twisting the armour wires.
- Freely rotating captive cone and inspectible cone ring an armour clamp and earth bond for steel wire armour.
- Factory fitted a specially formulated elastomeric seal for Built-in Safety™, lead seals on the lead sheath to IP65/66/68.
- Precision manufactured from high-quality brass (Marine Grade Electroless Nickel Plated™) available in stainless steel 316/316L on request.
- Complete with a thread sealing gasket.



Technical Data

Type:	E1EX Lead Seal
Gland Material:	Brass (Marine Grade Electroless Nickel Plated™), Stainless Steel 316/316L
Seal Material:	Standard Thermoset Elastomer or Extreme Temperature Seals and Lead
Seal Gasket Material:	HDPE, Nylon 66 or PTFE
Cable Type:	Steel Wire Armour, Lead Sheath
Armour Clamping:	Rotating Captive Cone and Inspectible Cone Ring
Sealing Area:	Inner Lead Sheath and Outer Sheath
Optional Accessories:	Adaptor, Reducer, Earth Tag, Locknut, Serrated Washer and Shroud
Note:	The installer should ensure that the materials are suitable for the installation environment.

Standards and Certifications

Equipment Protection Levels:	IECEX: Ex db IIC Gb, Ex eb IIC Gb, Ex nR IIC Gc, Ex tb IIIC Db ATEX: Ⓜ II 2GD, II 3G, Ex db IIC Gb, Ex eb IIC Gb, Ex nR IIC Gc TR CU: 1Ex d IIC Gb X / 1Ex e IIC Gb X / 2Ex nR IIC Gc X / Ex tb IIIC Db X	
Continuous Operating Temp:	Standard Seals: -60°C to +95°C/100°C (HDPE/Nylon Sealing Gasket) Extreme Temp. Seals: -60°C to +160°C (PTFE)	
Conformance:	Standard: Certificate:	
IEC/BS EN	IEC/BS EN 62444	CML 14CA364
IECEX	IEC 60079 Parts 0, 1, 7, 15, 31	IEC Ex CML 18.0018X
ATEX	EN 60079 Parts 0, 1, 7, 31 EN 60079 Parts 0, 15	CML 16ATEX1001X CML 16ATEX4002X
INMETRO (Brazil)	ABNT NBR IEC 60079 Parts 0, 1, 7, 15, 31	TÜV 15.0483X
TR CU (Russia)	ГОСТ Р МЭК 60079-0, 7, 15, 31, ГОСТ IEC 60079-1	RU C-ZA.ME92.B.00690
SANS	SANS 60079 Parts 0, 1, 7, 15, 31	MASC MS/13-028X IEC Ex CML 18.0018X
IP66/68 - Parallel	IEC 60529	
IP65/68 - Tapered	IEC 60529	
Deluge Protection	DTS-01	CML 14CA370-2
Corrosion Protection	ASTM B117-11, BS EN ISO 3231	EXOVA N968667
Marine ABS	IEC 60079 Parts 0, 1, 7, 15, 31, IEC 60529	ABS 20-SG1952706-PDA
EMC Compatible	EN 55011:2009 + A1:2010, EN 55022:2010	SGS EMC197708/1



Conditions for Safe Use - X

- The cable glands shall only be used where the temperature, at the point of entry, is between -60°C and +95°C (standard seal & HDPE sealing gasket), +100°C (standard seal and Nylon sealing gasket) or +160°C (extreme temp. seal & PTFE sealing gasket) depending on seal and gasket used.
- According to IEC 60079-14, 10.6.2: An Ex d gland will only maintain Ex d integrity when used with substantially round, compact and filled cable. If not a CCG QuickStop-Ex® barrier gland should be used.

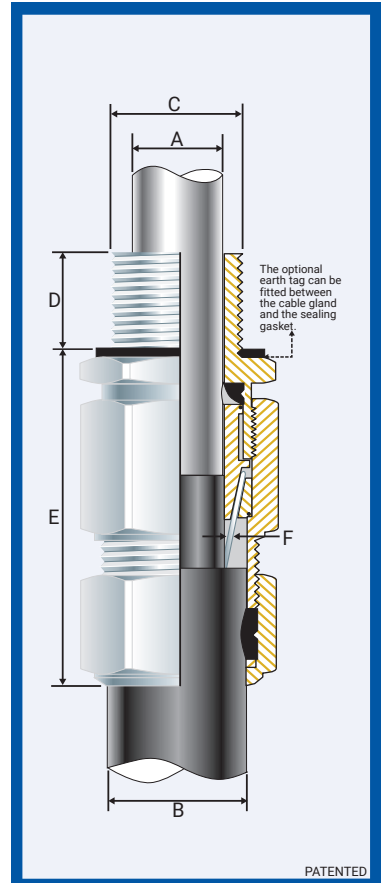

Product Code	Gland Size Reference	Metric Entry Thread		NPT Entry Thread		Cable Detail				Max Length 'E'	Armour Dia		Hexagonal Detail		Installation Torque Value Nm
		'C'	Min 'D'	'C'	Min 'D'	Lead Sheath		Min 'B'	Max 'B'		Min 'F'	Max 'F'	Max 'Flats'	Max 'Crns'	
						Min 'A'	Max 'A'								
052300-LS	00-20ss	M20x1.5	15	1/2/3/4	15	3.0	8.0	8.0	13.5	53.0	0.20	0.90	24/27	27/30	35.0
052301-LS	0-20s	M20x1.5	15	1/2/3/4	15	8.0	12.0	11.5	16.0	53.0	0.20	1.25	24/27	27/30	35.0
052302-LS	1-20	M20x1.5	15	1/2/3/4	15	11.0	15.0	14.5	20.5	56.0	0.20	1.25	27	30	35.0
052322-LS	2s-25s	M25x1.5	15	3/4/1	15/19	13.0	16.5	16.0	24.5	60.0	0.20	1.60	35	39	50.0
052302-LS	2-25	M25x1.5	15	3/4/1	15/19	13.0	16.5	20.5	26.5	60.0	0.20	1.60	35	39	50.0
052333-LS	3s-32s	M32x1.5	15	1/1 1/4	19	16.0	19.0	23.0	30.5	66.0	0.20	2.00	42	47	70.0
052303-LS	3-32	M32x1.5	15	1/1 1/4	19	18.0	20.5	26.5	33.5	66.0	0.20	2.00	42	47	70.0
052344-LS	4s-40s	M40x1.5	15	1 1/4/1 1/2	19/21	20.5	25.0	30.0	39.5	78.0	0.30	2.00	52	59	90.0
052304-LS	4-40	M40x1.5	15	1 1/4/1 1/2	19/21	25.0	29.0	33.0	42.5	78.0	0.30	2.00	52	59	90.0
052355-LS	5s-50s	M50x1.5	15	1 1/2/2	21	28.5	34.0	34.0	47.5	87.0	0.40	2.50	65	73	100.0
052305-LS	5-50	M50x1.5	15	1 1/2/2	21	33.5	36.0	42.5	52.5	87.0	0.40	2.50	65	73	100.0
052366-LS	6s-63s	M63x1.5	15	2/2 1/2	21/30	35.5	39.0	45.5	60.5	110.0	0.40	2.50	80	90	120.0
052306-LS	6m-63m	M63x1.5	15	2/2 1/2	21/30	38.5	42.0	52.5	65.5	110.0	0.40	2.50	80	90	120.0
052306L-LS	6L-63L	M63x1.5	15	2/2 1/2	21/30	41.5	44.0	52.5	65.5	110.0	0.40	2.50	80	90	120.0
052377-LS	7s-75s	M75x1.5	15	2 1/2/3	30/32	43.0	49.0	57.0	72.5	118.0	0.40	3.15	96	108	120.0
052307-LS	7m-75m	M75x1.5	15	2 1/2/3	30/32	49.0	56.0	65.5	78.0	118.0	0.40	3.15	96	108	120.0
052307L-LS	7L-75L	M75x1.5	15	2 1/2/3	30/32	56.0	59.0	65.5	78.0	118.0	0.40	3.15	96	108	120.0
052308-LS	8-80	M80x2.0	15	3	32	59.0	66.0	65.0	77.5	175.0	2.50	3.15	96	108	120.0
052399-LS	9s-90s	M90x2.0	15	3/3 1/2	32/33	66.0	73.0	73.0	86.5	184.0	3.00	4.00	111	125	120.0
052309-LS	9-90	M90x2.0	15	3/3 1/2	32/33	73.0	79.0	82.0	90.5	184.0	3.00	4.00	111	125	120.0
052310-LS	10-100	M100x2.0	15	3 1/2/4	33/34	78.0	88.0	91.0	100.0	189.0	3.00	4.00	125	141	120.0
052311-LS	11-115	M115x2.0	15	4	34	86.0	96.0	100.0	114.0	189.0	3.00	4.00	135	152	175.0
052312-LS	12-120	M120x2.0	15	-	-	96.0	100.0	103.0	118.0	189.0	3.00	4.00	140	158	175.0
052313-LS	13-130	M130x2.0	15	-	-	100.0	112.0	113.0	124.0	189.0	3.00	4.00	146	164	175.0

All dimensions except NPT are in mm. Exact dimensions of the cable lead sheath must be submitted to CCG before ordering.

Intermediate thread sizes are available on request.

CCG reserves the right to make alterations to the technical data, dimensions, designs and products available without notice. The illustrations cannot be considered binding. Please contact CCG for assistance.

E1EXLS-GH140420E

E1EX LEAD SEAL Ex db IIC, Ex eb IIC, Ex tb IIIC, Ex nR IIC

ENCLOSURES AND EQUIPMENT TO WHICH CABLE GLANDS ARE FITTED:-

- Must be made from materials which are compatible with the cable gland materials.
- Have a sealing area around the cable gland entry point with a surface roughness < Ra 6.3 µm.
- Have entries that are perpendicular to the enclosure face in the area where the cable gland will seal to within 2.5°.
- Are sealed using the supplied sealing gasket (parallel threads) or by fully tightening into a threaded entry (tapered threads). Note that for tapered threads the IP rating can be improved to IP68 with the use of a suitable thread sealant.

MUST HAVE THREADED ENTRIES

- The same thread size as the cable gland. (Thread adapters should be used to correct

any mismatch).

- With a thread tolerance of metric class '6H' or equivalent.
- Where the thread length is a minimum of 10mm for Ex d applications or 3mm for all other applications

OR CLEARANCE HOLES (not Ex d)

- Where the hole size is the thread nominal size with a tolerance of +0.1 to +0.7mm. (e.g. the clearance hole for an M20 thread will have a diameter between 20.1mm and 20.7mm).
- Through material that is between 1mm and 12mm thick. (Thicker materials can be accommodated using glands with extended entry threads.)

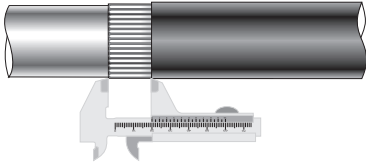

Gland Size	Armour Length	Gland Size	Armour Length	Gland Size	Armour Length
00-16ss	20.0	3-32	30.0	6m-63m	45.0
00-20ss	20.0	4s-40s	30.0	6L-63L	45.0
0-20s	20.0	4-40	30.0	7s-75s	50.0
1-20	25.0	5s-50s	35.0	7m-75m	50.0
2-25	25.0	5-50	35.0	7L-75L	50.0
3s-32s	30.0	6s-63s	45.0		

1. Cut back the cable outer sheath to expose the armour to a length as per the table above. Cut back the inner sheath to just before the armouring to expose lead sheath.

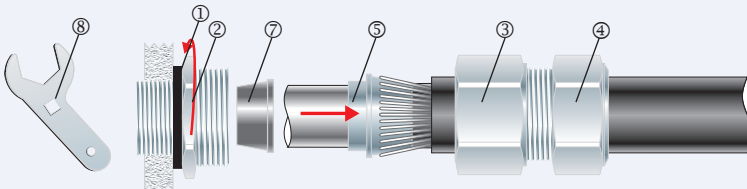

2. To maintain IP66/68 ensure the gasket ① is in place. Screw the gland unit onto the apparatus. Tighten the inner ② to installation torque using a CCG Spanner ⑧. Pass the cable end through the outer nut ④ and the body ③ over the cable. Splay the armour wires over the cone ⑤. Pass the lead seal ⑦ over the lead sheath.

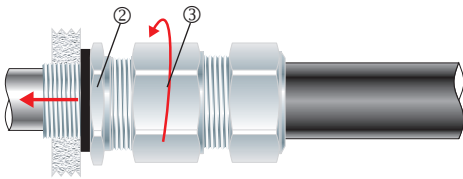

3. Pass the cable end through the inner ② and tighten the body ③ onto the inner ② to lock the armour between the cone ⑤ and the cone ring ⑥.

Alternative installation through an unthreaded entry.

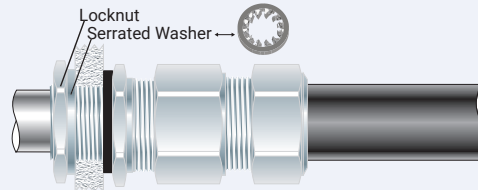

If the apparatus is unthreaded use a locknut.

4. Unscrew the body ③ and check that lead seal ⑦ has bonded onto the lead of the cable (lead seal must be tight). Check that the armour has locked between the cone ⑤ and the cone ring ⑥ (O-Ring on the cone ring ⑥ is sacrificial).

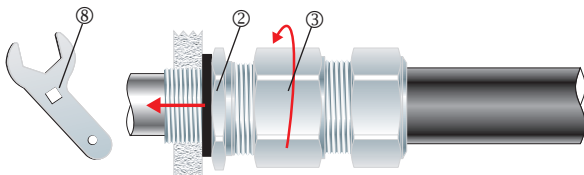

5. Pass the cable end through the inner ② and tighten the body ③ onto the inner ② to the installation torque using a CCG Spanner ⑧.

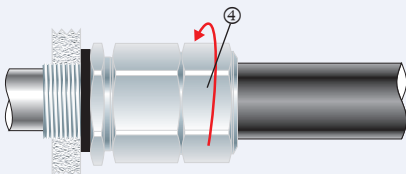

6. Tighten the outer nut ④ to produce a moisture proof seal by turning until the seal makes contact with outer sheath of cable and then make one full turn.