

CW INSULATED CAPTIVE COMPONENT GLAND®

for SWA and Aluminium Armoured Cable



Features and Benefits

- For indoor and outdoor use.
- Gland is insulated from equipment to prevent system circulating currents.
- Freely rotating captive cone and inspectible cone ring, providing an armour clamp and earth bond without twisting the armouring.
- Patented disconnect armoured clamp system for ease of inspection.
- Provides a seal on the outer sheath of the cable sealing to IP65/66.
- Precision manufactured from high-quality brass (nickel plated) available in aluminium or stainless steel 316/316L on request.
- Complete with heavy-duty (nickel plated) locknut.



Technical Data

Type:	CW Insulated
Gland Material:	Brass (Nickel Plated) BS 2874, EN 12164, Aluminium ASTM B221, Stainless Steel 316/316L
Seal Material:	Thermoset Elastomer
Cable Type:	Steel Wire Armour, Aluminium Armour Wire
Armour Clamping:	Rotating Captive Cone and Inspectible Cone Ring
Sealing Area:	Outer Sheath
Optional Accessories:	Adaptor, Reducer, Earth Tag, Serrated Washer and Shroud

Standards and Certifications

Mechanical Properties:	Impact Category 8 Anchorage Type D	
Electrical Properties:	Category B	
Continuous Operating Temp:	-65°C to +120°C	
Conformance:	Standard:	Certificate:
Design Standards	BS 6121:Part 1	CML 14CA364
	IEC/BS EN 62444	CML 14CA364
	SANS 62444	MASC 11-303
	SANS 1213	MASC 18-2047, SANS 2109/4596
IP66 - Parallel	IEC 60529	MASC 11-263
Marine ABS	IEC 62444	ABS 20-SG1952694-PDA
	DNV-GL IEC 60529, BS 6121, IEC 62444	DNV-GL TAE000000Z
EMC Compatible	EN 55011:2009 + A1:2010,	SGS EMC197708/1
	EN 55022:2010	
London Underground Approval	BS EN 62444	LU 3044

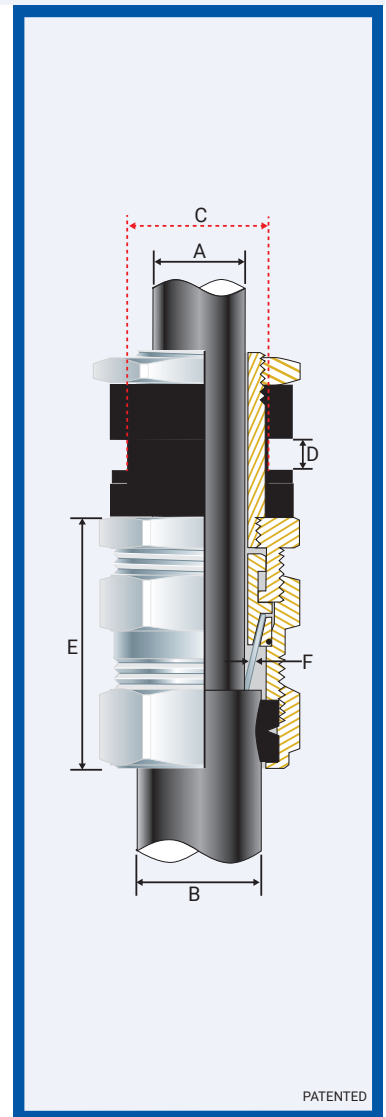

Installation Standards

- AS/NZS 3000
- BS 6121-5
- BS 7671
- BS 7430
- IEC 60364-5-54
- SANS 0142

Product Code	Gland Size Reference	Metric Entry Thread		Cable Detail			Max Length 'E'	Armour Dia		Hexagonal Detail		Install. Torque Value Nm
		'C'	Max 'D'	Max 'A'	Min 'B'	Max 'B'		Min 'F'	Max 'F'	Max 'Flats'	Max 'Crns'	
0532-0	0-20s	20	10	12.0	11.5	16.0	61.0	0.90	1.25	24.0	27.0	35.0
053201	1-20	20	10	13.5	14.5	21.0	67.0	0.90	1.25	27.0	30.0	35.0
053202	2-25	25	10	17.5	20.5	27.0	80.0	1.25	1.60	35.0	39.0	50.0
053203	3-32	32	10	24.0	26.5	33.5	80.0	1.60	2.00	42.0	47.0	70.0
053204	4-40	40	10	34.0	33.0	43.0	85.0	1.60	2.00	52.0	59.0	90.0
053205	5-50	50	10	42.5	40.5	52.5	106.0	2.00	2.50	65.0	73.0	100.0
053206	6-63	63	10	55.5	52.5	65.5	129.0	2.00	2.50	80.0	90.0	120.0
053207	7-75	75	10	68.0	65.5	78.0	149.0	2.50	3.15	96.0	108.0	120.0
053208	8-80	80	10	72.5	78.0	82.0	149.0	2.50	3.15	96.0	108.0	120.0
053209	9-90	90	10	81.5	82.0	91.0	157.0	3.00	3.50	96.0	108.0	120.0
053210	10-100	100	10	91.5	90.0	101.0	165.0	3.00	3.50	125.0	141.0	120.0
053211	11-110	110	10	98.0	100.0	114.0	165.0	3.00	4.00	135.0	152.0	120.0

All dimensions are in mm.

♦ When manufactured in Aluminium, Hex will be 27 Across Flats and 30 Across Corners.

CW INSULATED CAPTIVE COMPONENT GLAND®

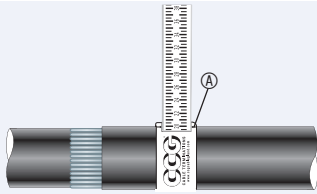

1. For accurate sizing, use a CCG Dimension Tape ④ on the inner and outer cable sheath.

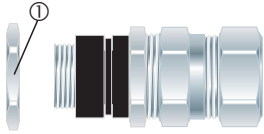

2. Remove the locknut ①.

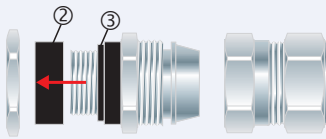

3. Remove female insulator ring ②. To maintain IP66 rating ensure the gasket ③ is in place.

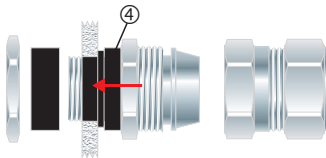

4. Insert the male insulator entry ④ into the cable entry of the apparatus.

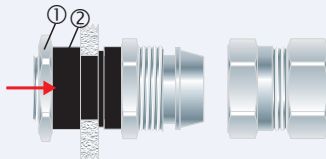

5. Screw the female insulator ring ② back against the apparatus (maximum of 10mm thickness). Screw the locknut ① back against the female insulator ring ②.

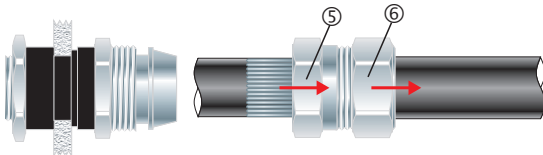

6. Pass the outer nut ⑥ and the body ⑤ over the cable and strip the cable outer sheath.

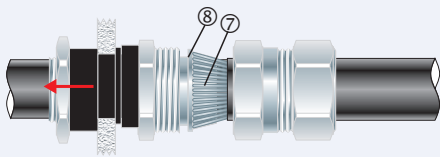

7. Pass cable end through the inner and splay the armour wires ⑦ over the cone ⑧.

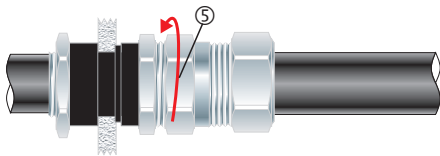

8. Tighten the body ⑤ onto the inner to lock the armour between the cone ⑧ and cone ring ⑨.

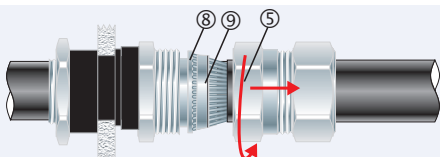

9. Unscrew the body ⑤. Check that the armour has locked between the cone ⑧ and cone ring ⑨. (O-Ring on the cone ring ⑨ is sacrificial).

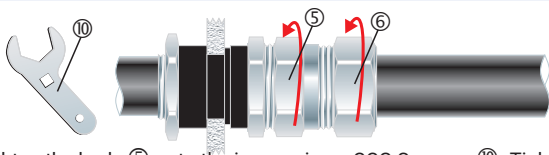

10. Tighten the body ⑤ onto the inner using a CCG Spanner ⑩. Tighten the outer nut ⑥ onto the body ⑤ to produce a moisture-proof seal by turning until seal makes contact with the outer sheath of the cable and then turn one full turn.