

POSI GRIP®

Ex db IIC, Ex eb IIC, Ex ta IIIC, Ex nR IIC

COMPRESSION GLAND for Unarmoured Cable



Features and Benefits

- Passes the IECEx / UKEX / ATEX 100% pull test, so no additional cable clamping is required.
- For highly corrosive Group II, III, Zone 1, 2, 20, 21 and 22 hazardous areas.
- Complete with a gripper seal, deluge-proof O-Ring, and elastomeric inner seal for complete explosion and ingress protection IP65/66/68.
- Brass parts are encapsulated in and protected by a corrosion-resistant material.
- Marine-grade electroless nickel-plated entry threads.
- Precision manufactured from high-quality brass (Marine Grade Electroless Nickel Plated™).
- Supplied with a thread-sealing gasket.



Technical Data

Type:	Posi Grip®
Gland Material:	Brass (Marine Grade Electroless Nickel Plated™) encapsulated in Glass Reinforced Polyester/PBT
Seal Material:	Standard Thermoset Elastomer
Cable Type:	Unarmoured
Sealing Area:	Outer Sheath
Optional Accessories:	Adaptor, Reducer, Locknut, Serrated Washer and *CCG Posi™ Spanner
Note:	The installer should ensure that the materials are suitable for the installation environment.

Standards and Certifications

Equipment Protection Levels:	IECEX/INMETRO: Ex db IIC Gb, Ex eb IIC Gb, Ex nR IIC Gc, Ex ta IIIC Da ATEX/UKEX: Ex II 2/3G 1D, Ex db IIC Gb, Ex eb IIC Gb, Ex nR IIC Gc, Ex ta IIIC Da TR CU: Ex I Ex d IIC Gb X / 1Ex e IIC Gb X / 2Ex nR IIC Gc X / Ex tb IIIC Db XX	
Continuous Operating Temp:	-20°C to +95°C (Glass reinforced polyester) -60°C to 100°C (Nylon)	
Conformance:	Standard:	Certificate:
IEC/BS EN	IEC/BS EN 62444	CML 14CA364
IECEX	IEC 60079 Part 0, 1, 7, 15, 31	IECEX CML 20.0011
ATEX	EN 60079 Part 0, 1, 7, 31	CML 20ATEX1026
	EN 60079 Part 0, 15	CML 22ATEX4116
UKEX	BS EN 60079 Part 0, 1, 7, 31	CML 21UKEX1013
	BS EN 60079 Part 0, 15	CML 22UKEX4117
INMETRO (Brazil)	ABNT NBR IEC 60079 Part 0, 1, 7, 15, 31	TUV 15.0483
	ГОСТ 31610-0, 15, ГОСТ IEC 60079-1	EAЭC RU C-ZA.HA91.B.00245/21
TR CU (Russia)	ГОСТ P MЭК 60079-7, 31	
SANS	SANS/IEC 60079 Part 0, 1, 7, 15, 31	MASC S/20-9022
IP66/68 100m - Parallel	IEC 60529	CML 15Y728
Deluge Protection	DTS-01	CML 14CA370-2
Corrosion Protection	ASTM B117-11, BS EN ISO 3231	EXOVA N968667
Marine ABS	IEC 60079 Part 0, 1, 7, 15, 31, IEC 60529	ABS 20-1952706-1-PDA
	DNV	IEC 60079 Part 0, 1, 7, 15, 31, IEC 60529

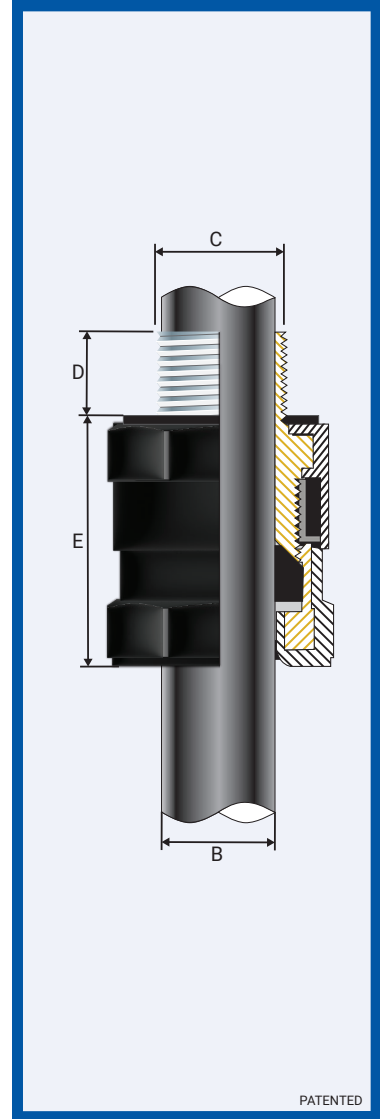

Conditions for Safe Use - X

- None

Product Code	Gland Size Reference	Metric Entry Thread		Cable Detail		Maximum Length 'E'	Hexagonal Detail		#Installation Torque Value Nm
		'C'	Min 'D'	Min 'B'	Max 'B'		Max 'Flats'	Max 'Crns'	
054500	00-20ss	M20x1.5	15	3.0	8.5	42.0	30.0	33.8	32.5
0545-0	0-20s	M20x1.5	15	7.0	12.0	42.0	30.0	33.8	32.5
054501	1-20	M20x1.5	15	11.0	15.0	46.0	34.0	38.3	32.5
054502	2-25	M25x1.5	15	15.0	20.0	51.0	42.0	47.3	47.5
054503	3-32	M32x1.5	15	20.0	26.5	60.0	52.0	58.5	55.0
054504	4-40	M40x1.5	15	26.0	34.0	65.0	62.0	69.8	65.0
054505	5-50	M50x1.5	15	34.0	44.5	75.0	74.0	83.3	82.5
054506	6-63	M63x1.5	15	44.5	56.5	107.0	95.0	106.9	97.5
054507	7-75	M75x1.5	15	56.0	67.5	107.0	111.0	124.9	115.5
054508	8-80	M80x2.0	20	54.0	69.0	128.0	117.0	131.6	120.0
054509	9-90	M90x2.0	20	73.0	81.5	133.0	130.0	146.3	120.0
054510	*10-100	M100x2.0	20	81.0	92.0	170.0	140.0	157.5	120.0
054511	*11-110	M110x2.0	20	91.0	101.0	170.0	150.0	168.8	175.0

All dimensions are in mm. # Only CCG Posi™ Spanner to be used for installation torque.

* Size 10 - 11: Available only on request.

POSI GRIP® GLAND

ENCLOSURES AND EQUIPMENT TO WHICH CABLE GLANDS ARE FITTED:-

- Must be made from materials which are compatible with the cable gland materials.
- Have a sealing area around the cable gland entry point with a surface roughness <math>< Ra 6.3 \mu m.</math>
- Have entries that are perpendicular to the enclosure face in the area where the cable gland will seal to within 2.5°.
- Are sealed using the supplied sealing gasket.

MUST HAVE THREADED ENTRIES

- The same thread size as the cable gland. (Thread adapters should be used to correct any mismatch).

- With a thread tolerance of metric class '6H' or equivalent.
- Where the thread length is a minimum of 10mm for Ex d applications or 3mm for all other applications

OR CLEARANCE HOLES (not Ex d)

- Where the hole size is the thread nominal size with a tolerance of +0.1 to +0.7mm. (e.g. the clearance hole for an M20 thread will have a diameter between 20.1mm and 20.7mm).
- Through material that is between 1mm and 12mm thick. (Thicker materials can be accommodated using glands with extended entry threads).

The gland may only be installed / dismantled using the tool available from CCG (CCG Posi™ Spanner).

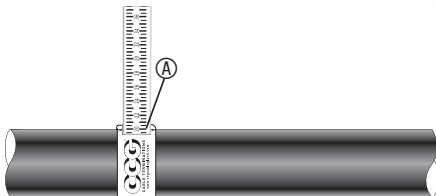

1. For accurate sizing, use a CCG Dimension Tape (A) on the outer cable sheath.

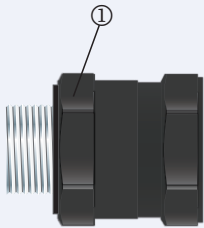

2. To maintain IP66/68, ensure the thread gasket (1) is in place.

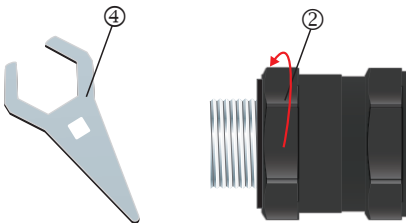

3. Screw the gland unit into the apparatus. Tighten the nipple nut (2) as per torque value using a CCG Posi Spanner (4).

* Only CCG Posi™ Spanner to be used for installation torque.

Alternative installation through an unthreaded entry.

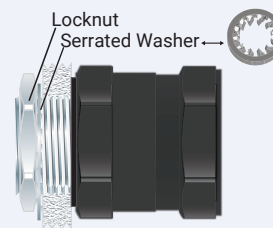

If the apparatus is untapped use a locknut.

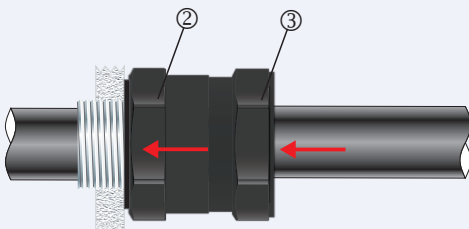

4. Pass the cable end through the outer nut (3) nipple nut (2).

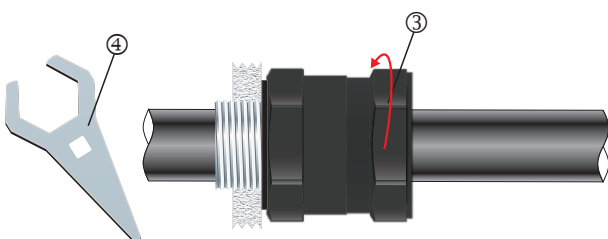

5. Tighten the outer nut (3) using a CCG Posi Spanner (4) as per torque value using a CCG Posi Spanner (4) to produce a seal and grip on the cable.

* Only CCG Posi™ Spanner to be used for installation torque.