



# IPLUS™ CORROSION GUARD™

## CAPTIVE COMPONENT GLAND®

### for Steel Wire Armoured Cable

#### Features and Benefits

- For highly corrosive and wet locations.
- Factory fitted captive elastomeric seals for Built-in Safety™.
- The screw-on Corrosion Guard™ is manufactured from non-corrosive material to protect the armour and metal parts of the gland.
- Corrosion Guard™ screws onto the gland body and seals over the outer sheath of the cable giving an IP66/68 and deluge proof seal.
- Cable Gland is precision manufactured from high-quality brass (nickel plated).
- Complete with sealing gasket and with a heavy-duty locknut.



#### Technical Data

Type:	IPlus™ Corrosion Guard™	
Gland Material:	Brass (Nickel Plated) BS 2874, EN 12164	
Corrosion Guard Material:	Glass Reinforced Polyester Compound / PBT	
Seal Material:	Thermoset Elastomer (Standard)	
Cable Type:	Steel Wire Armour	
Armour Clamping:	Captive Rotating Cone and Inspectible Cone Ring	
Sealing Area:	Inner and Outer sheath and total enclosure of the metal gland body	
Optional Accessories:	Adaptor, Reducer, Locknut and Serrated Washer	

#### Standards and Certifications

Mechanical Properties:	Impact Category 8 Anchorage Type D	
Electrical Properties:	Category A (no earth tag) Category B (with earth tag)	
Continuous Operating Temp:	-65°C to +120°C	
Conformance:	Standard:	Certificate:
Design Standards	BS 6121:Part 1	CML 14CA364
	EN 50262	CML 14CA364
	IEC/BS EN 62444	CML 14CA364
	SANS 62444	MASC 11-303
	SANS 1213	MASC 18-2047, SANS 2109/4596
IP66/68 100m	IEC 60529	CML 15Y728
Corrosion Protection	ASTM B117-11, BS EN ISO 3231	N968667
Marine ABS	IEC 62444	ABS 20-SG1952694-PDA
	DNV-GL	IEC 60529, BS 6121, IEC 62444
EMC Compatible	EN 55011:2009 + A1:2010,	SGS EMC197708/1
	EN 55022:2010	
London Underground Approval	BS EN 62444	LU 3043

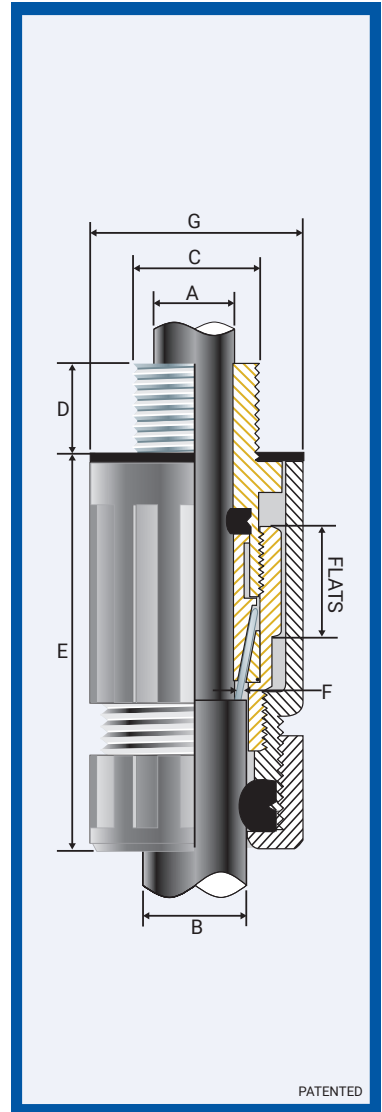

#### Installation Standards

- AS/NZS 3000
- BS 6121-5
- BS 7671
- BS 7430
- IEC 60364-5-54
- SANS 0142

Product Code	Gland Size Reference	Metric Entry Thread		Cable Detail				Max Length 'E'	Armour Dia		Max Dia 'G'	Hexagonal Detail		Installation Torque Value Nm
		'C'	Min 'D'	Min 'A'	Max 'A'	Min 'B'	Max 'B'		Min 'F'	Max 'F'		Max 'Flats'	Max 'Crns'	
054600-16-IP	00-16ss	M16x1.5	10	3.0	8.5	8.0	13.5	50.0	-	0.90	35.0	♦ 24.0	♦ 27.0	35.0
054600-IP	00-20ss	M20x1.5	10	3.0	8.5	8.0	13.5	50.0	-	0.90	35.0	♦ 24.0	♦ 27.0	35.0
0546-0-IP	0-20s	M20x1.5	10	7.0	12.0	11.5	16.0	50.0	0.90	1.25	35.0	♦ 24.0	♦ 27.0	35.0
054601-IP	1-20	M20x1.5	10	11.5	15.0	14.5	20.5	61.0	0.90	1.25	36.5	27.0	30.0	35.0
054602-IP	2-25	M25x1.5	10	14.0	20.0	20.5	26.5	68.0	1.25	1.60	46.0	35.0	39.0	50.0
054603-IP	3-32	M32x1.5	10	19.0	26.5	26.5	33.5	75.0	1.60	2.00	53.0	42.0	47.0	70.0
054604-IP	4-40	M40x1.5	15	26.0	34.0	33.0	42.5	86.0	1.60	2.00	68.0	52.0	59.0	90.0
054605-IP	5-50	M50x1.5	15	34.0	44.5	42.5	52.5	102.0	2.00	2.50	84.0	65.0	73.0	100.0
054606-IP	6-63	M63x1.5	15	44.0	56.5	52.5	65.5	122.0	2.00	2.50	110.0	80.0	90.0	120.0
054607-IP	7-75	M75x1.5	15	56.0	67.5	65.5	78.0	135.0	2.00	3.15	124.0	96.0	108.0	120.0
054608-IP	8-80	M80x2.0	20	68.0	74.0	78.0	82.0	160.0	2.50	3.15	124.0	96.0	108.0	120.0
054609-IP	9-90	M90x2.0	20	74.0	81.5	82.0	91.0	170.0	3.00	3.50	140.0	111.0	125.0	120.0
054610-IP	10-100	M100x2.0	20	81.0	91.0	90.0	100.0	180.0	3.00	3.50	140.0	125.0	141.0	120.0

All dimensions are in mm.

♦ When manufactured in Aluminium, Hex will be 27 Across Flats and 30 Across Corners.

# IP PLUS™ CORROSION GUARD™ GLAND

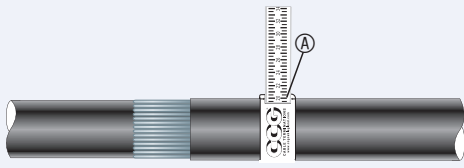

1. For accurate sizing, use a CCG Dimension Tape **A** on the inner and outer cable sheath.

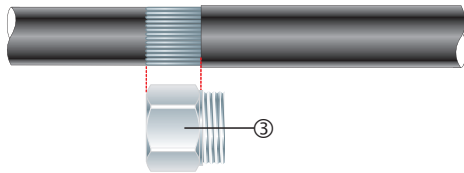

2. Cut back the cable outer sheath to expose the armour to a length not more than the body **3**.

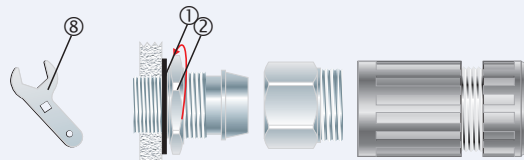

3. To maintain IP66/68 ensure gasket **1** is in place. Screw the inner **2** into apparatus. Tighten the inner **2** to installation torque using a CCG Spanner **8**. For untapped entries use a locknut.

*Alternative installation through an unthreaded entry.*

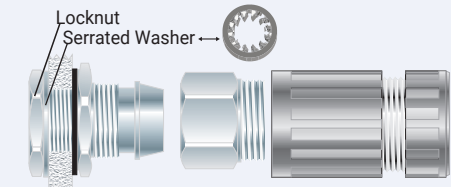

If the apparatus is untapped use a locknut.

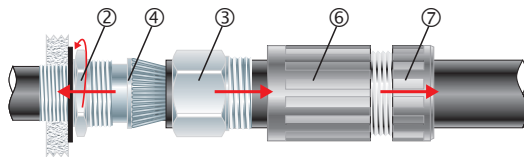

4. Pass the corrosion guard outer nut **7**, corrosion guard body **6** and body **3** over the cable. Pass the cable end through the inner **2** and splay the armour wires over the cone **4**.

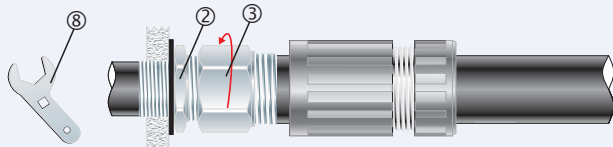

5. Tighten the body **3** onto the inner **2** until hand tight, then tighten with a CCG Spanner **7** with  $\frac{3}{4}$  turn to lock the armour between the cone **4** and the cone ring **5**.

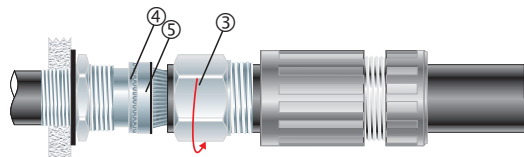

6. Unscrew the body **3**. Check that the armour has locked between the cone **4** and cone ring **5**. (O-Ring on the cone ring **5** is sacrificial).

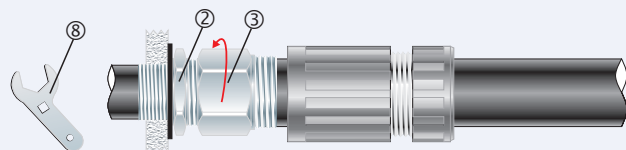

7. Tighten the body **3** onto the inner **2**. Tighten the body **3** to installation torque using a CCG Spanner **8**.

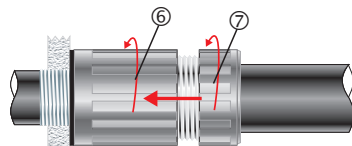

8. Slide corrosion guard body **6** and corrosion guard outer nut **7** over assembled gland, screw corrosion guard body **6** onto the gland. **Hand tighten** corrosion guard body **6** and corrosion guard outer nut **7** to produce the required dust and waterproof seal IP66/68.