

Ex CORROSION GUARD®

Ex db IIC, Ex eb IIC, Ex tb IIIC, Ex nR IIC

CABLE GLAND for Steel and Aluminium Armoured Cable



Features and Benefits

- For highly corrosive, wet locations, Group II, III, Zone 1, 2, 21 and 22 hazardous areas.
- Factory fitted captive elastomeric seals for Built-in Safety™.
- Two-part handling, freely rotating captive cone and inspectible cone ring provides an armour clamp and earth bond on steel wire and aluminium armour.
- Corrosion Guard® screws onto the gland body and seals over the outer sheath of the cable giving an IP68 and deluge proof seal protecting the armour and metal parts of the gland.
- Precision manufactured from high-quality brass (Marine Grade Electroless Nickel Plated™).
- Complete with thread sealing gasket.



Technical Data

Type:	Ex Corrosion Guard®
Gland Material:	Brass (Marine Grade Electroless Nickel Plated™)
Corrosion Guard Material:	Glass Reinforced Polyester Compound / PBT
Seal Material:	Standard Thermoset Elastomer
Seal Gasket Material:	HDPE, Nylon 66 or PTFE
Cable Type:	Steel Wire, Aluminium Armour
Armour Clamping:	Captive Rotating Cone and Inspectible Cone Ring
Sealing Area:	Inner Sheath, Outer Sheath and total enclosure of gland
Optional Accessories:	Adaptor, Reducer, Locknut and Serrated Washer
Note:	The installer should ensure that the materials are suitable for the installation environment.

Standards and Certifications

Equipment Protection Levels:	IECEX: Ex db IIC Gb, Ex eb IIC Gb, Ex nR IIC Gc, Ex tb IIIC Db ATEX: Ⓜ II 2GD, II 3G, Ex db IIC Gb, Ex eb IIC Gb, Ex tb IIIC Db, Ex nR IIC Gc TR CU: 1Ex d IIC Gb X / 1Ex e IIC Gb X / 2Ex nR IIC Gc X / Ex tb IIIC Db X	
Continuous Operating Temp:	Standard Seals: -60°C to +95°C/100°C (HDPE/Nylon Sealing Gasket) Extreme Temp. Seals: -60°C to +120°C (PTFE)	
Conformance:	Standard:	Certificate:
IEC/BS EN	IEC/BS EN 62444	CML 14CA364
IECEX	IEC 60079 Parts 0, 1, 7, 15, 31	IEC Ex CML 18.0018X
ATEX	EN 60079 Parts 0, 1, 7, 31 EN 60079 Parts 0, 15	CML 16ATEX1001X CML 16ATEX4002X
INMETRO (Brazil)	ABNT NBR IEC 60079 Parts 0, 1, 7, 15, 31	TÜV 15.0483X
TR CU (Russia)	ГОСТ Р МЭК 60079-0, 7, 15, 31, ГОСТ IEC 60079-1	TC RU C-ZA.ME92.B.00690
SANS	SANS 60079 Parts 0, 1, 7, 15, 31	MASC MS/13-028X
IP66/68 100m	IEC 60529	CML 15Y728
Deluge Protection	DTS-01	CML 14CA370-2
Corrosion Protection	ASTM B117-11, BS EN ISO 3231	EXOVA N968667
Marine ABS	IEC 60079 Parts 0, 1, 7, 15, 31 and IEC 60529	ABS 20-SG1952706-PDA
DNV-GL	IEC 60079 Parts 0, 1, 7 and IEC 60529	DNV-GL TAE0000010
EMC Compatible	EN 55011:2009 + A1:2010, EN 55022:2010	SGS EMC197708/1

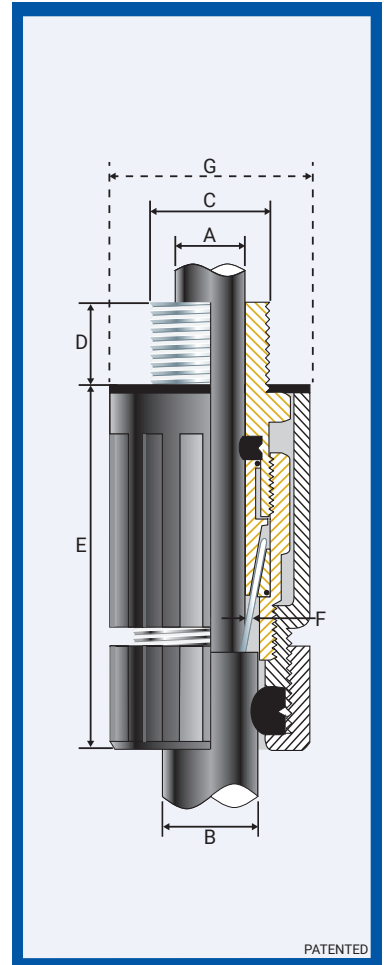

Conditions for Safe Use - X

- The cable glands shall only be used where the temperature, at the point of entry, is between -60°C and +95°C (standard seal & HDPE sealing gasket), +100°C (standard seal and Nylon sealing gasket) or +120°C (extreme temp. seal & PTFE sealing gasket) depending on seal and gasket used.
- According to IEC 60079-14, 10.6.2: An Ex d gland will only maintain Ex d integrity when used with substantially round, compact and filled cable that is at least 3m long. If not a CCG QuickStop-Ex® barrier gland should be used.

Product Code	Gland Size Reference	Metric Entry Thread		Cable Detail				Max Length 'E'	Armour Dia		Max Dia 'G'	Hexagonal Detail		Install. Torque Value Nm
		'C'	Min 'D'	Min 'A'	Max 'A'	Min 'B'	Max 'B'		Min 'F'	Max 'F'		Max 'Flats'	Max 'Crns'	
054700-16	00-16ss	M16x1.5	15	3.0	8.5	8.0	13.5	46.0	0.20	0.90	33.0	24.0	27.0	21.0
054700	00-20ss	M20x1.5	15	3.0	8.5	8.0	13.5	46.0	0.20	0.90	33.0	24.0	27.0	21.0
0547-0	0-20s	M20x1.5	15	7.0	12.0	11.5	16.0	46.0	0.20	1.25	33.0	24.0	27.0	21.0
054701	1-20	M20x1.5	15	9.0	15.0	14.5	20.5	51.0	0.20	1.25	36.0	27.0	30.0	21.0
054722	2s-25s	M25x1.5	15	11.0	17.5	16.0	24.5	58.0	0.20	1.60	46.0	35.0	39.0	30.0
054702	2-25	M25x1.5	15	14.0	20.0	20.5	26.5	58.0	0.20	1.60	46.0	35.0	39.0	30.0
054733	3s-32s	M32x1.5	15	15.0	22.0	23.0	30.5	67.0	0.20	2.00	53.0	42.0	47.0	42.0
054703	3-32	M32x1.5	15	19.0	26.5	26.5	33.5	67.0	0.20	2.00	53.0	42.0	47.0	42.0
054744	4s-40s	M40x1.5	15	22.0	31.5	30.0	39.5	74.0	0.30	2.00	68.0	52.0	59.0	52.0
054704	4-40	M40x1.5	15	26.0	34.0	33.0	42.5	74.0	0.30	2.00	68.0	52.0	59.0	52.0
054755	5s-50s	M50x1.5	15	29.0	38.0	34.0	47.5	89.0	0.40	2.50	84.0	65.0	73.0	57.0
054705	5-50	M50x1.5	15	34.0	44.5	42.5	52.5	89.0	0.40	2.50	84.0	65.0	73.0	57.0
054766	6s-63s	M63x1.5	15	38.0	50.0	45.5	60.5	102.0	0.40	2.50	110.0	80.0	90.0	66.0
054706	6-63	M63x1.5	15	44.0	56.5	52.5	65.5	102.0	0.40	2.50	110.0	80.0	90.0	66.0
054777	7s-75s	M75x1.5	15	50.0	62.0	57.0	72.5	106.0	0.40	3.15	124.0	96.0	108.0	72.0
054707	7-75	M75x1.5	15	56.0	67.5	65.5	78.0	106.0	0.40	3.15	124.0	96.0	108.0	72.0
054708	8-80	M80x2.0	20	59.0	69.0	65.0	77.5	117.0	2.50	3.15	124.0	96.0	108.0	80.0
054799	9s-90s	M90x2.0	20	66.0	75.0	73.0	86.5	117.0	3.00	3.50	124.0	111.0	125.0	89.0
054709	9-90	M90x2.0	20	74.0	81.5	82.0	91.0	117.0	3.00	3.50	140.0	111.0	125.0	89.0
054710	10-100	M100x2.0	20	81.0	91.0	90.0	100.0	117.0	3.00	3.50	140.0	125.0	141.0	98.0

All dimensions are in mm. Intermediate thread sizes are available on request.

CCG reserves the right to make alterations to the technical data, dimensions, designs and products available without notice. The illustrations cannot be considered binding. Please contact CCG for assistance.

EXCG-GH140420

EX CORROSION GUARD® Ex db IIC, Ex eb IIC, Ex tb IIC, Ex nR IIC

ENCLOSURES AND EQUIPMENT TO WHICH CABLE GLANDS ARE FITTED:-

- Must be made from materials which are compatible with the cable gland materials.
- Have a sealing area around the cable gland entry point with a surface roughness <math>< Ra 6.3 \mu m</math>.
- Have entries that are perpendicular to the enclosure face in the area where the cable gland will seal to within 2.5°.
- Are sealed using the supplied sealing gasket.

MUST HAVE THREADED ENTRIES

- The same thread size as the cable gland. (Thread adapters should be used to correct any mismatch).

- With a thread tolerance of metric class '6H' or equivalent.

- Where the thread length is a minimum of 10mm for Ex d applications or 3mm for all other applications

OR CLEARANCE HOLES (not Ex d)

- Where the hole size is the thread nominal size with a tolerance of +0.1 to +0.7mm. (e.g. the clearance hole for an M20 thread will have a diameter between 20.1mm and 20.7mm).

- Through material that is between 1mm and 12mm thick. (Thicker materials can be accommodated using glands with extended entry threads).

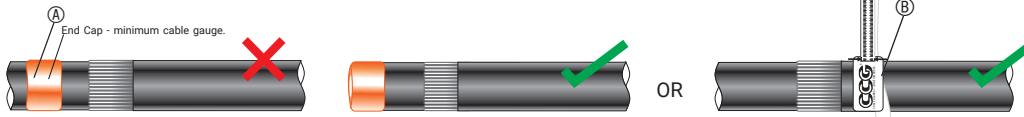

1. Check the correct gland size using an end cap (patented) (A). If the cable sheath passes through the hole in the end cap (A), use a gland one size smaller. For accurate sizing, use a CCG Dimension Tape (B) on the cable sheath.

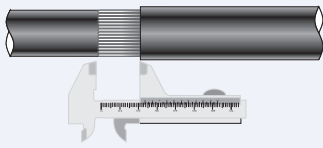

Gland Size	Armour Length	Gland Size	Armour Length	Gland Size	Armour Length	Gland Size	Armour Length
00-16ss	20.0	2-25	25.0	5s-50s	35.0	7-75	50.0
00-20ss	20.0	3s-32s	30.0	5-50	35.0	8-80	50.0
0-20s	20.0	3-32	30.0	6s-63s	45.0	9s-90s	50.0
1-20	25.0	4s-40s	30.0	6-63	45.0	9-90	50.0
2s-25s	25.0	4-40	30.0	7s-75s	50.0	10-100	60.0

2. Cut back the cable outer sheath to expose the armour to a length as per the table above.

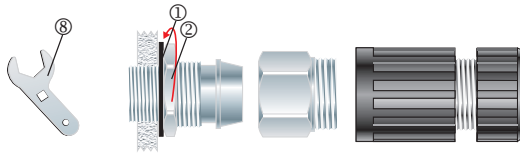

3. To maintain IP66/68 ensure gasket (1) is in place. Screw the inner (2) into apparatus. Tighten the inner (2) to installation torque using a CCG Spanner (8).

Alternative installation through an unthreaded entry.

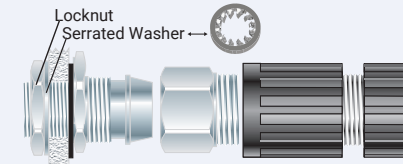

If the apparatus is untapped use a locknut.

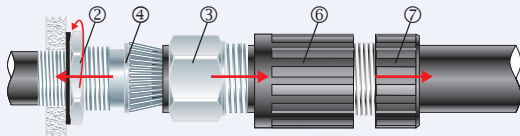

4. Pass the corrosion guard outer nut (7), corrosion guard body (6) and the gland body (3) over the cable. Pass the cable end through the inner (2) and splay the armour wires over the cone (4).

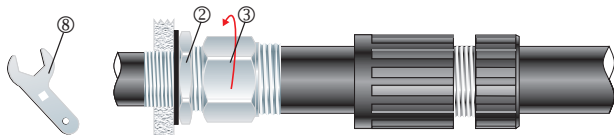

5. Screw the gland body (3) onto the inner (2) and tighten the gland body (3) using a CCG Spanner (8) to lock the armour between the cone (4) and the cone ring (5).

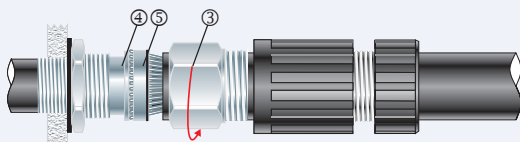

6. Unscrew the body (3). Check that the armour has locked between the cone (4) and the cone ring (5). (O-Ring on the cone ring (5) is sacrificial).

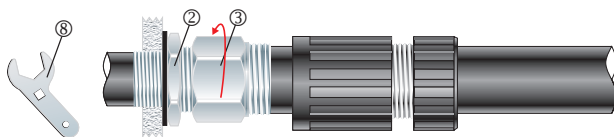

7. Screw the gland body (3) onto the inner (2). Tighten the gland body (3) to installation torque using a CCG Spanner (8).

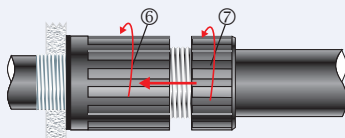

8. Slide corrosion guard body (6) and corrosion guard outer nut (7) over assembled gland, screw corrosion guard body (6) onto the gland. **Hand tighten** corrosion guard body (6) and corrosion guard outer nut (7) to produce the required dust and waterproof seal IP66/68.