

CWe

Ex eb IIC, Ex tb IIIC

CABLE GLAND WITH VARIABLE DELUGE SEAL™ for Steel Wire and Aluminium Armour Cable



Features and Benefits

- For indoor, outdoor Group II and III, Zone 1, 2, 21 and 22 hazardous areas.
- Two-piece handling, no loose parts. Freely rotating captive cone and inspectible cone ring provides an armour clamp and earth bond without twisting the armouring.
- With a patented Variable Deluge Seal™ as standard.
- Provides a seal on the outer sheath of the cable sealing to IP68.
- Patented disconnect armoured clamp system for ease of inspection.
- Precision manufactured from high-quality brass (Marine Grade Electroless Nickel Plated™) available aluminium or stainless steel 316/316L on request.
- Supplied with a thread sealing gasket (parallel threads only).

Technical Data

Type:	CWe
Gland Material:	Brass (Marine Grade Electroless Nickel Plated™) BS 2874, EN 12164, Aluminium ASTM B221, Stainless Steel 316/316L
Seal Material:	Thermoset Elastomer or Silicon on request
Sealing Gasket Material:	HDPE, Nylon 66 or PTFE
Cable Type:	Steel Wire Armour, Aluminium Armour Wire
Armour Clamping:	Rotating Captive Cone and Inspectible Cone Ring
Sealing Area:	Outer Sheath and Variable Deluge Seal™
Optional Accessories:	Adaptor, Reducer, Earth Tag, Locknut, Serrated Washer and Shroud
Note:	The installer should ensure that the materials are suitable for the installation environment.

Standards and Certifications

Equipment Protection Levels:	IECEX/INMETRO: Ex eb IIC Gb, Ex tb IIIC Db AEX/UKEx: (E) II 2 G D, Ex eb IIC Gb, Ex tb IIIC Db TR CU: Ex 1Ex e IIC Gb X, Ex tb IIIC Db X	
Continuous Operating Temp:	Standard Seals: -60°C to +95°C/100°C (HDPE/Nylon Sealing Gasket) Extreme Temp. Seals: -60°C to +160°C (PTFE Sealing Gasket)	
Conformance:	Standard: Certificate:	
IEC/BS EN	IEC/BS EN 62444	CML 14CA364
IECEX	IEC 60079 Part 0, 7, 31	IECEX CML 18.0018X
ATEX	EN 60079 Part 0, 7, 31	CML 16ATEX1001X
UKEX	BS EN 60079 Parts 0, 1, 7, 31	CML 21UKEX1011X
INMETRO (Brazil)	ABNT NBR IEC 60079 Part 0, 1, 7, 15, 31	TÜV 15.0483X
TR CU (Russia)	ГОСТ 31610-0, 15, ГОСТ IEC 60079-1 ГОСТ P MЭК 60079-7, 31	EA9C RU C-ZA.HA91.B.00245/21
SANS	SANS/IEC 60079 Part 0, 1, 7, 15, 31	MASC MS/13-028X
IP66/68 850m - Parallel	IEC 60529	CML 15Y728
IP65 - Tapered	IEC 60529	
IP68 - Tapered and approved grease	IEC 60529	IEC Ex CML 18.0018X
Deluge Protection	DTS-01	CML 14CA370-2
Corrosion Protection	ASTM B117-11, BS EN ISO 3231	EXOVA N968667
Marine ABS	IEC/EN 60079 Part 0, 1, 7, 15, 31	ABS 20-1952706-1-PDA
DNV-GL	IEC 60079 Part 0, 1, 7, IEC 60529	DNV-GL TAE0000010
EMC Compatible	EN 55011:2009, EN 55022:2010	SGS EMC197708/1

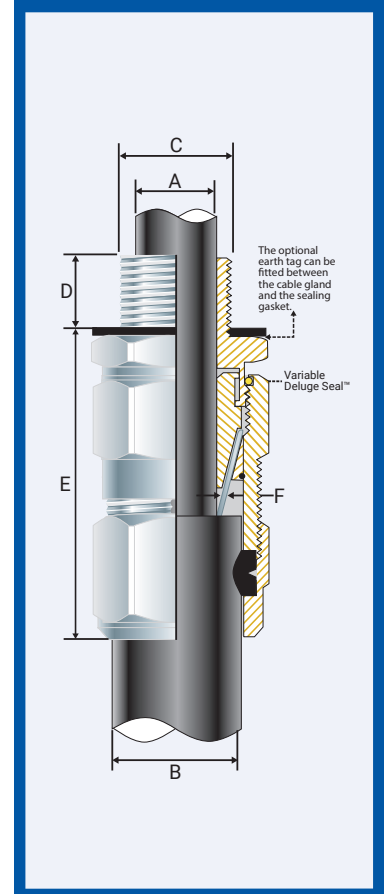

Conditions for Safe Use - X

- The cable gland shall only be used where the temperature, at the point of entry, is between -60°C to +95°C (standard seal and HDPE sealing gasket), -60°C to +100°C (standard seal and Nylon sealing gasket) or -60°C to 160°C (extreme temp. seal & PTFE sealing gasket) depending on seal and gasket used.

Product Code	Gland Size Reference	Metric Entry Thread		NPT Entry Thread		Cable Detail			Max Length 'E'	Armour Dia		Hexagonal Detail		Install Torque Value Nm
		'C'	Min 'D'	'C'	Min 'D'	Max 'A'	Min 'B'	Max 'B'		Min 'F'	Max 'F'	Max 'Flats'	Max 'Crns'	
055700-16	00-16ss	M16x1.5	15	-	-	8.5	8.0	13.5	41.0	0.90	0.90	24.0	27.0	35.0
055700	00-20ss	M20x1.5	15	1/2/3/4	15	8.5	8.0	13.5	41.0	0.90	0.90	24.0	27.0	35.0
0557-0-16	0-16s	M16x1.5	15	1/2/3/4	15	10.5	11.5	16.0	43.0	0.90	1.25	24.0	27.0	35.0
0557-0	0-20s	M20x1.5	15	1/2/3/4	15	12.0	11.5	16.0	43.0	0.90	1.25	24.0	27.0	35.0
055701	1-20	M20x1.5	15	1/2/3/4	15	15.0	14.5	20.5	47.0	0.90	1.25	27.0	30.0	35.0
055722	2s-25s	M25x1.5	15	3/4/1	15/19	17.5	16.0	24.5	56.0	1.25	1.60	35.0	39.0	50.0
055702	2-25	M25x1.5	15	3/4/1	15/19	20.0	20.5	26.5	56.0	1.25	1.60	35.0	39.0	50.0
055733	3s-32	M32x1.5	15	1/1 1/4	19	22.0	23.0	30.5	57.0	1.60	2.00	42.0	47.0	70.0
055703	3-32	M32x1.5	15	1/1 1/4	19	26.5	26.5	33.5	57.0	1.60	2.00	42.0	47.0	70.0
055744	4s-40s	M40x1.5	15	1 1/4/1 1/2	19/21	31.5	30.0	39.5	68.0	1.60	2.00	52.0	59.0	90.0
055704	4-40	M40x1.5	15	1 1/4/1 1/2	19/21	34.0	33.0	42.5	68.0	1.60	2.00	52.0	59.0	90.0
055755	5s-50s	M50x1.5	15	1 1/2/2	21	38.0	34.0	47.5	72.0	2.00	2.50	65.0	73.0	100.0
055705	5-50	M50x1.5	15	1 1/2/2	21	38.0/44.5	42.5	52.5	72.0	2.00	2.50	65.0	73.0	100.0
055766	6s-63s	M63x1.5	15	2/2 1/2	21/30	50.0	45.5	60.5	89.0	2.00	2.50	80.0	90.0	120.0
055706	6-63	M63x1.5	15	2/2 1/2	21/30	50.0/56.5	52.5	65.5	89.0	2.00	2.50	80.0	90.0	120.0
055777	7s-75s	M75x1.5	15	2 1/2/3	30/32	62.0	57.0	72.5	97.0	2.50	3.15	96.0	108.0	120.0
055707	7-75	M75x1.5	15	2 1/2/3	30/32	62.0/67.5	65.5	78.0	97.0	2.50	3.15	96.0	108.0	120.0
055788	8s-80s	M80x2.0	20	3	32	69.0	65.0	77.5	98.0	2.50	3.15	96.0	108.0	120.0
055708	8-80	M80x2.0	20	3	32	74.0	78.0	82.0	98.0	2.50	3.15	96.0	108.0	120.0
055799	9s-90s	M90x2.0	20	3/3 1/2	32/33	75.0	73.0	86.5	123.0	3.00	3.50	111.0	125.0	120.0
055709	9-90	M90x2.0	20	3/3 1/2	32/33	75.0/81.5	82.0	91.0	123.0	3.00	3.50	111.0	125.0	120.0
055710	10-100	M100x2.0	20	3 1/2/4	33/34	91.0	90.0	100.0	124.0	3.00	3.50	125.0	141.0	120.0
055711	11-115	M115x2.0	20	4	34	98.0	100.0	114.0	134.0	3.00	4.00	135.0	152.0	120.0
055712	12-120	M120x2.0	20	-	-	103.0	103.0	118.0	136.0	3.00	4.00	140.0	158.0	120.0
055713	13-130	M130x2.0	20	-	-	115.0	113.0	124.0	140.0	3.00	4.00	146.0	164.0	120.0

All dimensions except NPT are in mm. Intermediate thread sizes are available on request. NPT threads should be tightened 'wrench tight'.

CCGG reserves the right to make alterations to the technical data, dimensions, designs and products available without notice. The illustrations cannot be considered binding. Please contact CCGG for assistance.

CWE_GH011121E

CWe GLAND WITH VARIABLE DELUGE SEAL™ Ex eb IIC, Ex tb IIIC

ENCLOSURES AND EQUIPMENT TO WHICH CABLE GLANDS ARE FITTED:-

- Must be made from materials which are compatible with the cable gland materials.
- Have a sealing area around the cable gland entry point with a surface roughness <math>< Ra 6.3 \mu m</math>.
- Have entries that are perpendicular to the enclosure face in the area where the cable gland will seal to within 2.5°.
- Are sealed using the supplied sealing gasket (parallel threads) or by fully tightening into a threaded entry (tapered threads). Note that for tapered threads the IP rating can be improved to IP68 with the use of a suitable thread sealant.

MUST HAVE THREADED ENTRIES

- The same thread size as the cable gland. (Thread adapters should be used to correct

any mismatch).

- With a thread tolerance of metric class '6H' or equivalent.
- Where the thread length is a minimum of 10mm for Ex d applications or 3mm for all other applications

OR CLEARANCE HOLES (not Ex d)

- Where the hole size is the thread nominal size with a tolerance of +0.1 to +0.7mm. (e.g. the clearance hole for an M20 thread will have a diameter between 20.1mm and 20.7mm).
- Through material that is between 1mm and 12mm thick. (Thicker materials can be accommodated using glands with extended entry threads.)

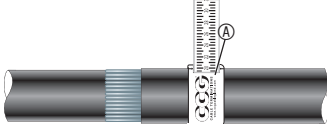

1. For accurate sizing, use a CCG Dimension Tape [Ⓐ] on the inner and outer cable sheath.

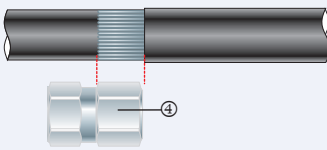

2. Cut back the cable outer sheath to expose the armour to a length not more than the outer nut [Ⓓ].

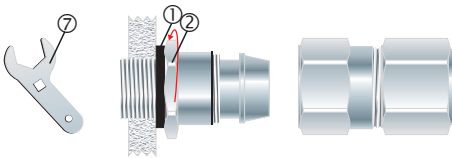

3. To maintain IP68 ensure the gasket [Ⓛ] is in place. Screw the inner [Ⓜ] into the apparatus. Tighten the inner [Ⓜ] to the installation torque using a CCG Spanner [Ⓡ].

Alternative installation through an unthreaded entry.

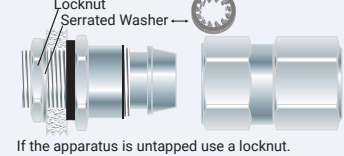

If the apparatus is untapped use a locknut.

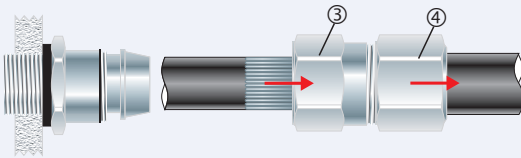

4. Pass the outer nut [Ⓓ] and body [Ⓝ] over the cable.

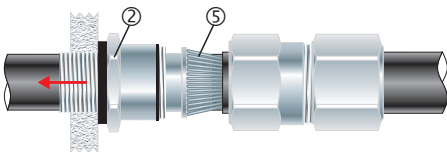

5. Pass cable end through the inner [Ⓜ] and splay the armour wires over the cone [Ⓟ].

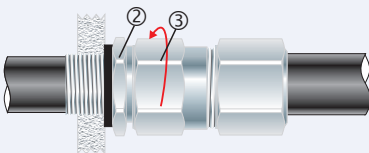

6. Tighten the body [Ⓝ] onto the inner [Ⓜ] until hand tight, then tighten with a CCG Spanner [Ⓡ] with $\frac{3}{4}$ turn to lock the armour between the cone [Ⓟ] and the cone ring [Ⓠ].

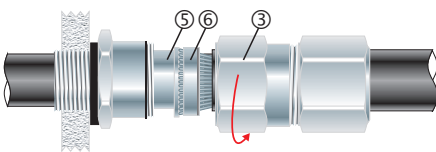

7. Unscrew the body [Ⓝ]. Check that the armouring has locked between the cone [Ⓟ] and the cone ring [Ⓠ]. (O-Ring on the cone ring [Ⓠ] is sacrificial).

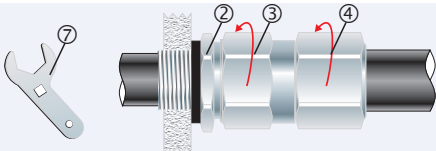

8. Screw the body [Ⓝ] onto the inner [Ⓜ] and tighten the body [Ⓝ] to the installation torque using a CCG Spanner [Ⓡ]. The Variable Deluge Seal™ will engage automatically as the body is tightened onto the inner [Ⓜ]. Tighten the outer nut [Ⓓ] to produce a moisture-proof seal by turning until the seal makes contact with outer sheath of cable and then make one full turn.