



UNITEx™ VX

Ex db IIC, Ex eb IIC, Ex tb IIIC, Ex nR IIC

VORTEX® BARRIER GLAND WITH VARIABLE DELUGE SEAL™

for Unfilled Multi Armoured and Marine Cables

Features and Benefits

- For indoors, outdoors, Group II, III, Zone 1, 2, 21 and 22 hazardous areas.
- For Unfilled hygroscopic multicore cables refer to IEC 60079-14; 9.3.2 and 10.6.2a, IEC 61892-7, 10.6 and 10.7.
- Freely rotating captive cone and inspectable cone ring provides an armour clamp and earth bond on steel wire armour, aluminium wire armour, tape armour, braid wire armour cables and NEK 606 marines cable susceptible to cold flow.
- With a patented Variable Deluge Seal™ as standard.
- Instantly mixed and injected resin forms a 100% barrier seal around the individual cores of the cable.
- Prevents explosive gases and/or liquids transmitting down the cable.
- Precision manufactured from high-quality brass (Marine Grade Electroless Nickel Plated™) available in stainless steel 316/316L on request.
- Complete with thread sealing gasket.



Technical Data

Type:	UNITEx™ VX [VORTEX®]
Gland Material:	Brass (Marine Grade Electroless Nickel Plated™) or Stainless Steel 316/316L
Seal Material:	Standard Thermoset Elastomer or Extreme Temperature Seals, Quick setting Injection Resin Barrier Seal
Seal Gasket Material:	HDPE, Nylon 66 or PTFE
Cable Type:	Steel Wire, Aluminium, Braided and Tape Armour Cable Exhibiting Cold Flow
Armour Clamping:	Rotating Captive Cone and Inspectable Cone Ring
Sealing Area:	Outer Sheath, Variable Deluge Seal™ and VORTEX® Resin around Cable Conductors
Optional Accessories:	Adaptor, Reducer, Earth Tag, Locknut, Serrated Washer and Shroud
Note:	The installer should ensure that the materials are suitable for the installation environment.

Standards and Certifications

Equipment Protection Levels:	IECEX: Ex db IIC, Ex eb IIC, Ex tb IIIC, Ex nR IIC ATEX: Ex db IIC, Ex eb IIC, Ex tb IIIC, Ex nR IIC
Continuous Operating Temp:	Standard Seals -50°C to +95°C/100°C (HDPE/Nylon Sealing Gasket) Extreme Temp. Seals: -50°C to +120°C (PTFE Sealing Gasket)
Conformance:	Standard: Certificate: IEC/BS EN IEC/BS EN 62444
IECEX	IEC 60079 Parts 0, 1, 7, 15, 31 IEC Ex CML 18.0018X
ATEX	EN 60079 Parts 0, 1, 7, 31 CML 16ATEX1001X EN 60079 Parts 0, 15 CML 16ATEX4002X
IP66/68 - Parallel	IEC 60529 CML 15Y728
IP65/66 - Tapered	IEC 60529
Deluge Protection	DTS-01 CML 14CA370-2
Corrosion Protection	ASTM B117-11, BS EN ISO 3231 EXOVA N968667
Marine ABS	IEC/EN 60079 Parts 0, 1, 7, 15, 31 ABS 20-SG1952706-PDA
EMC Compatible	EN 55011:2009 + A1:2010, EN 55022:2010



Conditions for Safe Use - X

- The cable glands shall only be used where the temperature, at the point of entry, is between -50°C and +95°C (standard seal & HDPE sealing gasket), +100°C (standard seal and Nylon sealing gasket) or +120°C (extreme temp. seal & PTFE sealing gasket) depending on seal and gasket used.
- Braided cables must only be used on fixed installations where the cable is clamped or stress applied to the cable in the gland is prevented.
- Only Resin supplied by CCG may be used in the glands.

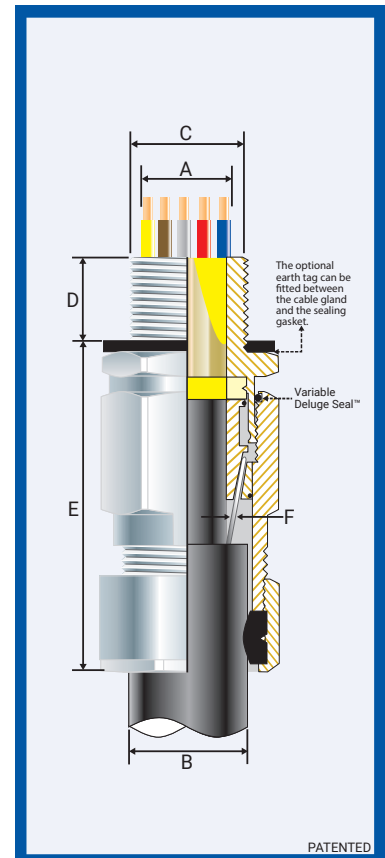

Product Code	Gland Size Reference	Metric Entry Thread		NPT Entry Thread		Cable Detail				Max Length 'E'	Max Dia. Over Cores	Max No. of Cores	Armour Dia		Hex Detail		Install. TRQ Value Nm
		'C'	Min 'D'	'C'	Min 'D'	Min 'A'	Max 'A'	Min 'B'	Max 'B'				Min 'F'	Max 'F'	Max 'Flats'	Max 'Crns'	
055900S-16-VX	00s-16ss	M16x1.5	15	-	-	3.0	8.5	5.0	10.5	62.0	8.0	6	0.2	0.9	24.0	27.0	21.0
055900S-20-VX	00s-20ss	M20x1.5	15	1/2 3/4	15	3.0	8.5	5.0	10.5	62.0	10.9	6	0.2	0.9	24.0	27.0	21.0
055900-VX	00-20ss	M20x1.5	15	1/2 3/4	15	3.0	8.5	8.0	14.0	61.0	10.9	6	0.2	0.9	24.0	27.0	21.0
0559-0S-16-VX	0s-16s	M16x1.5	15	-	-	7.0	12.0	8.0	14.0	64.0	8.0	6	0.2	1.25	24.0	27.0	21.0
0559-0S-VX	0s-20s	M20x1.5	15	1/2 3/4	15	7.0	12.0	8.0	14.0	64.0	10.9	6	0.2	1.25	24.0	27.0	21.0
0559-0-VX	0-20s	M20x1.5	15	1/2 3/4	15	7.0	12.0	11.5	16.0	64.0	10.9	6	0.2	1.25	24.0	27.0	21.0
055901-VX	1-20	M20x1.5	15	1/2 3/4	15	9.0	15.0	12.5	20.5	76.0	12.5	13	0.2	1.25	27.0	30.0	21.0
055922-VX	2s-25s	M25x1.5	15	3/4 1	15/19	11.0	17.5	16.0	24.5	90.0	15.5	20	0.2	1.60	35.0	39.0	30.0
055902-VX	2-25	M25x1.5	15	3/4 1	15/19	14.0	20.0	18.0	27.0	90.0	15.5	20	0.2	1.60	35.0	39.0	30.0
055933-VX	3s-32s	M32x1.5	15	1 1/4	19	15.0	22.0	20.0	30.5	103.0	21.7	40	0.2	2.00	42.0	47.0	42.0
055903-VX	3-32	M32x1.5	15	1 1/4	19	19.0	26.5	23.0	33.5	103.0	21.7	40	0.2	2.00	42.0	47.0	42.0
055944-VX	4s-40s	M40x1.5	15	1 1/4 1 1/2	19/21	22.0	31.5	26.5	39.0	105.0	30.0	60	0.3	2.00	52.0	59.0	52.0
055904-VX	4-40	M40x1.5	15	1 1/4 1 1/2	19/21	26.0	34.0	28.0	40.0	110.0	30.0	60	0.3	2.00	52.0	59.0	52.0
055955-VX	5s-50s	M50x1.5	15	1 1/2 2	21	29.0	38.0	35.2	47.5	129.0	36.3	80	0.4	2.50	65.0	73.0	57.0
055905-VX	5-50	M50x1.5	15	1 1/2 2	21	34.0	44.5	44.4	52.8	129.0	36.3	80	0.4	2.50	65.0	73.0	57.0
055966-VX	6s-63s	M63x1.5	15	2 2/2 2 1/3	21/30	38.0	50.0	45.5	60.5	137.0	47.9	100	0.4	2.50	80.0	90.0	66.0
055906-VX	6-63	M63x1.5	15	2 2/2 2 1/3	21/30	44.0	56.5	54.6	65.9	137.0	47.9	100	0.4	2.50	80.0	90.0	66.0
055977-VX	7s-75s	M75x1.5	15	2 1/2 3	30/32	50.0	62.0	59.0	72.5	157.0	58.2	120	0.4	3.15	96.0	108.0	72.0
055907-VX	7-75	M75x1.5	15	2 1/2 3	30/32	56.0	67.5	65.0	78.0	157.0	58.2	120	0.4	3.15	96.0	108.0	72.0
055908-VX	8-80	M80x2.0	20	3	32	59.0	69.0	65.0	77.5	156.0	61.5	140	0.4	3.15	96.0	108.0	80.0
055999-VX	9s-90s	M90x2.0	20	3 3/2 3 2/3	32/33	66.0	75.0	73.0	86.5	174.0	70.5	160	0.4	3.50	111.0	125.0	89.0
055909-VX	9-90	M90x2.0	20	3 3/2 3 2/3	32/33	74.0	81.5	82.0	91.0	174.0	70.5	160	0.4	3.50	111.0	125.0	89.0
055910-VX	10-100	M100x2.0	20	3 1/2 4	33/34	81.0	91.0	90.0	100.0	193.0	79.0	180	0.4	3.50	125.0	141.0	98.0

All dimensions except NPT are in mm. Intermediate thread sizes are available on request.

CCGG reserves the right to make alterations to the technical data, dimensions, designs and products available without notice. The illustrations cannot be considered binding. Please contact CCG for assistance. UNITEx VX-OMG210820E

UNITEx™ VX BARRIER GLAND Ex db IIC, Ex eb IIC, Ex tb IIIC, Ex nR IIC

ENCLOSURES AND EQUIPMENT TO WHICH CABLE GLANDS ARE FITTED:-

- Must be made from materials which are compatible with the cable gland materials.
- Have a sealing area around the cable gland entry point with a surface roughness <math>< Ra 6.3 \mu m.</math>
- Have entries that are perpendicular to the enclosure face in the area where the cable gland will seal to within 2.5°.
- Are sealed using the supplied sealing gasket (parallel threads) or by fully tightening into a threaded entry (tapered threads). Note that for tapered threads the IP rating can be improved to IP68 with the use of a suitable thread sealant.

MUST HAVE THREADED ENTRIES

- The same thread size as the cable gland. (Thread adapters should be used to correct

- any mismatch).
 - With a thread tolerance of metric class '6H' or equivalent.
 - Where the thread length is a minimum of 10mm for Ex d applications or 3mm for all other applications
- OR CLEARANCE HOLES (not Ex d)**
- Where the hole size is the thread nominal size with a tolerance of +0.1 to +0.7mm. (e.g. the clearance hole for an M20 thread will have a diameter between 20.1mm and 20.7mm).
 - Through material that is between 1mm and 12mm thick. (Thicker materials can be accommodated using glands with extended entry threads.)

1. For accurate sizing, use a CCG Dimension Tape ④ on the inner and outer cable sheath.

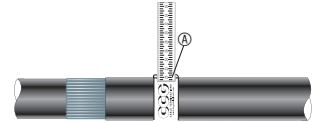

2. Separate the inner ② from the body ③. Cut back the cable outer sheath to expose the armour to a length as per the table below. Strip back the inner bedding to expose the inner cable cores using the cone ⑤ as a gauge.

Gland Size	Armour Length	Gland Size	Armour Length	Gland Size	Armour Length	Gland Size	Armour Length
00-16ss	20.0	3s-32s	30.0	6s-63s	45.0	9-90	50.0
00-20ss	20.0	3-32	30.0	6-63	45.0	10-100	60.0
0-20s	20.0	4s-40s	30.0	7s-75s	50.0	11-115	60.0
1-20	25.0	4-40	30.0	7-75	50.0	12-120	60.0
2s-25s	25.0	5s-50s	35.0	8-80	50.0	13-130	60.0
2-25	25.0	5-50	35.0	9s-90s	50.0		

If the cable cores have screens these should be cut away or twisted together into a single core. This single core should be insulated with heat shrink tubing or coated with insulating varnish. Any drain wires should also be insulated with heat shrink tubing or coated with insulating varnish.

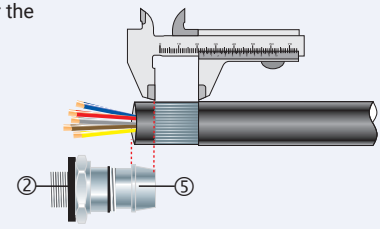

3. Using a clean cloth, clean the cable cores.

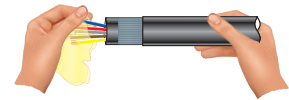

4. Using the insulation tape, bundle the cores together at the end.

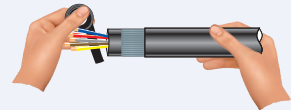

5. Ensure the thread gasket ① is in place. Screw the inner ② into the apparatus and tighten to the installation torque using a CCG Spanner ⑦. If the apparatus is untapped use a locknut. Pass the bundled cable cores through the outer nut ④ and the body ③. Pass the bundled cables cores through the inner ② and inner diaphragm seal and splay the armour wires over the cone ⑤.

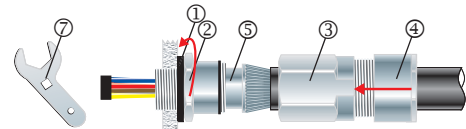

6. Tighten the body ③ onto the inner ② until hand tight, then tighten with a CCG Spanner ⑦ with 3/4 turn to lock the armour between the cone ⑤ and the cone ring ⑥.

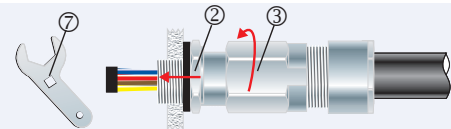

7. Unscrew the body ③. Check that the armour has locked between the cone ⑤ and the cone ring ⑥ (O-Ring on the cone ring ⑥ is sacrificial). Withdraw the barrier pot sub-assembly ⑧ and bundled cables. Remove the insulation tape.

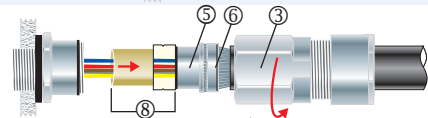

8. Remove the cap ⑪ from resin applicator and attach the mixing nozzle ⑫ (use extension nozzle for small multicore cables). Whilst holding the barrier pot sub-assembly ⑧ upright and holding the diaphragm seal firmly against the cable sheath inject the resin into the resin chamber. Make sure the resin fills the inspectible resin seal pot ⑨ all the way to the top of the protective resin pot ⑩ and wipe any excess resin away.

Wait for the resin to set from a liquid to a gel, this should take:

- 15 minutes at 10°C
- 7 minutes at 20°C
- 6 minutes at 30°C
- 5 minutes at 40°C

For installations in less than 5°C Ambient, warm the Resin Tube in warm water at ± 50°C. If there is still resin left in the tube, discard the mixing nozzle ⑫ and replace the cap ⑪ for use with the next gland.

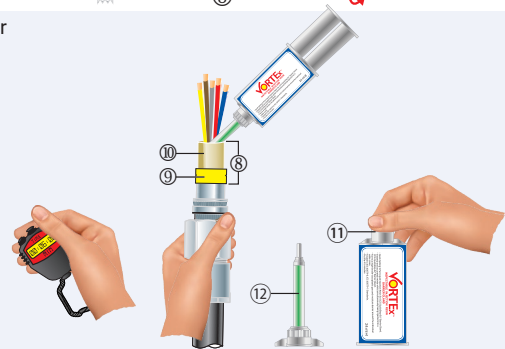

9. Re-insert the barrier pot sub-assembly ⑧ back into the inner ②.

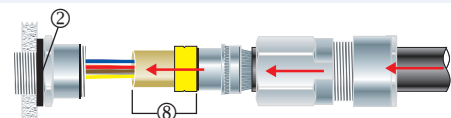

10. Tighten the body ③ onto the inner ② to the required torque using a CCG Spanner ⑦. The Variable Deluge Seal™ will engage automatically as the body ③ is tightened onto the inner ②. Tighten the outer nut ④ to produce a moisture proof seal by turning until the seal makes contact with the outer sheath of cable and then make one full turn.

