



E1EX-U LEAD SEAL

Ex db I/ IIC, Ex eb I/IIC, Ex ta IIIC, Ex nR IIC

CABLE GLAND for Lead Sheathed Multi Armoured Cable

Features and Benefits

- For indoors, outdoors, Group I, II, III, Zone 1, 2, 21 and 22 hazardous areas.
- Two part handling, no loose parts.
- Freely rotating captive cone ring, providing an armour clamp and earth bond without twisting the armour wires.
- Freely rotating captive cone and inspectible cone ring an armour clamp and earth bond.
- Factory fitted with a specifically formulated elastomeric seal for Built-in Safety™, lead seals on the lead sheath to IP65/66/68.
- Precision manufactured from high-quality brass (Marine Grade Electroless Nickel Plated™) available in stainless steel 316/316L on request.
- Supplied with a thread sealing-gasket (parallel threads only).



Technical Data

Type:	E1EX-U Lead Seal
Gland Material:	Brass (Marine Grade Electroless Nickel Plated™), Stainless Steel 316/316L
Seal Material:	Standard Thermoset Elastomer or Extreme Temperature Seals and Lead
Sealing Gasket Material:	HDPE, Nylon 66 or PTFE
Cable Type:	Steel Wire Armour, Lead Sheath
Armour Clamping:	Rotating Captive Cone and Inspectible Cone Ring
Sealing Area:	Inner Lead Sheath and Outer Sheath
Optional Accessories:	Adaptor, Reducer, Earth Tag, Locknut, Serrated Washer and Shroud
Note:	The installer should ensure that the materials are suitable for the installation environment.

Standards and Certifications

Equipment Protection Levels:	IECEX/INMETRO: Ex d I Mb/ IIC Gb, Ex e I Mb/IIC Gb, Ex nR IIC Gc, Ex ta IIIC Da ATEX/UKEX: Ex I M2, Ex II 2/3G 1D, Ex db I Mb/ IIC Gb, Ex eb I Mb/IIC Gb, Ex nRIIC Gc, Ex ta IIIC Da TR CU: Ex I Ex d IIC Gb X / PB Ex d I Mb X / 1Ex e IIC Gb X / PPI Ex e I Mc X / 2Ex nR IIC Gc X / Ex tb IIIC Db X CCC: Ex db IIC Gb, Ex eb IIC Gb, Ex ta IIIC Da	
Continuous Operating Temp:	Standard Seals: -60°C to +95°C /100°C (HDPE/ Nylon Sealing Gasket) Extreme Temp. Seals: -60°C to +160°C (PTFE Sealing Gasket)	
Conformance:	Standard:	Certificate:
IEC/BS EN	IEC/BS EN 62444	CML 14CA364
IECEX	IEC 60079 Part 0, 1, 7, 15, 31	IECEX TSA 22.0011X
ATEX	EN 60079 Part 0, 1, 7, 31	CML 16ATEX1001X
	EN 60079 Part 0, 15	CML 16ATEX4002X
UKEX	BS EN 60079 Part 0, 1, 7, 31	CML 21UKEX1011X
	BS EN 60079 Part 0, 15	CML 21UKEX4006X
INMETRO (Brazil)	ABNT NBR IEC 60079 Part 0, 1, 7, 15, 31	TUV 15.0483X
CCC/CNEX (Chinese)	GB/T3836.1, 2, 3, 31-2021	CNEX 21.3387X, CCC 2021312313000396
SANS	SANS/IEC 60079 Part 0, 1, 7, 15, 31	MASC MS/22-9001X
IP66/68 - Parallel	IEC 60529	CML 15Y728
IP65/66 - Tapered	IEC 60529	
Deluge Protection	DTS-01	
Corrosion Protection	ASTM B117-11, BS EN ISO 3231	CML 14CA370-2
Marine ABS	IEC 60079 Part 0, 1, 7, 15, 31, IEC 60529	EXOVA N968667
DNV	IEC 60079 Part 0, 1, 7, IEC 60529	ABS 20-1952706-1-PDA
EMC Compatible	EN 55011, + A1, EN 55022	TAE0000010 SGS EMC305079/1

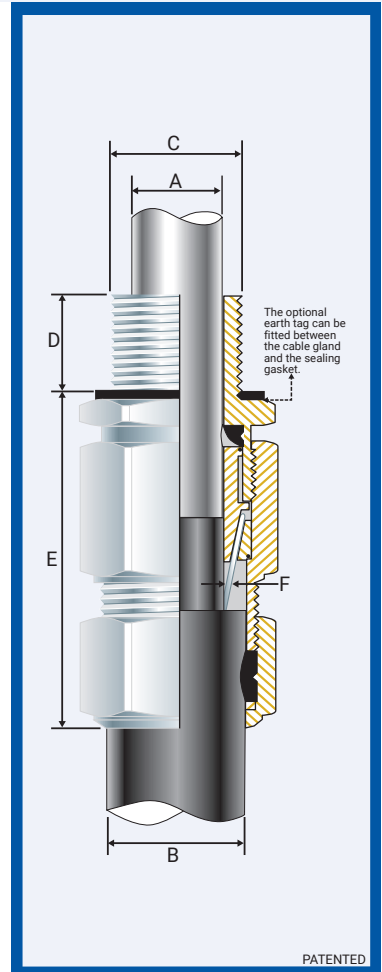

Conditions for Safe Use - X

- The cable glands shall only be used where the temperature, at the point of entry, is between -60°C to +95°C (standard seals & HDPE sealing gaskets), -60°C to +100°C (standard seal and Nylon sealing gasket) or -60°C to +160°C (extreme temp. seal & PTFE sealing gasket) depending on seal and gasket used.
- Braided cables are only suitable for Group II or III applications with this gland and the user shall ensure adequate clamping of the cable.

Note: According to IEC 60079-14, 10.6.2: An Ex d gland will only maintain Ex d integrity when used with substantially round, compact and filled cable. If not a CCG VORTEX® barrier gland should be used.

Product Code	Gland Size Reference	Metric Entry Thread		NPT Entry Thread		Cable Detail				Max Length 'E'	Armour Dia		Hexagonal Detail		Installation Torque Value Nm
		'C'	Min 'D'	'C'	Min 'D'	Lead Sheath		Min 'B'	Max 'B'		Min 'F'	Max 'F'	Max 'Flats'	Max 'Crns'	
						Min 'A'	Max 'A'								
057100-16-LS	00-16ss	M16x1.5	15	-	-	3.0	8.0	5.0	10.5	60.0	0.20	0.90	25/27	28/30	21.0
057100S-LS	00s-20ss	M20x1.5	15	1/2 3/4	15	8.0	12.0	5.0	10.5	60.0	0.20	0.90	25/27	28/30	21.0
057100-L	00-20ss	M20x1.5	15	1/2 3/4	15	11.0	15.0	8.0	13.5	60.0	0.20	0.90	25/27	28/30	21.0
0571-0S-LS	0s-20s	M20x1.5	15	1/2 3/4	15	13.0	16.5	8.0	13.5	60.0	0.20	1.25	25/27	28/30	21.0
0571-0-L	0-20s	M20x1.5	15	1/2 3/4	15	13.0	16.5	11.5	16.0	60.0	0.20	1.25	25/27	28/30	21.0
057101-LS	1-20	M20x1.5	15	1/2 3/4	15	16.0	19.0	12.5	20.5	73.0	0.20	1.25	30	34	21.0
057122-LS	2s-25s	M25x1.5	15	3/4 1	15/19	18.0	20.5	16.0	24.5	82.4	0.20	1.60	38	43	30.0
057102-LS	2-25	M25x1.5	15	3/4 1	15/19	20.5	25.0	18.0	27.0	82.0	0.20	1.60	38	43	30.0
057133-LS	3s-32s	M32x1.5	15	1 1/4	19	25.0	29.0	20.0	30.5	91.0	0.20	2.00	45	51	42.0
057103-LS	3-32	M32x1.5	15	1 1/4	19	28.5	34.0	23.0	33.5	91.0	0.20	2.00	45	51	42.0
057144-LS	4s-40s	M40x1.5	15	1 1/4 1 1/2	19/21	33.5	36.0	26.5	39.5	105.0	0.30	2.00	55	62	52.0
057104-LS	4-40	M40x1.5	15	1 1/4 1 1/2	19/21	35.5	39.0	28.0	40.0	105.0	0.30	2.00	55	62	52.0
057155-LS	5s-50s	M50x1.5	15	1 1/2 2	21	38.5	42.0	35.2	46.7	123.0	0.40	2.50	65	73	57.0
057105-LS	5-50	M50x1.5	15	1 1/2 2	21	41.5	44.0	44.4	53.0	123.0	0.40	2.50	65	73	57.0
057166-LS	6s-63s	M63x1.5	15	2 1/2 2 1/2	21/30	43.0	49.0	45.5	59.4	147.0	0.40	2.50	85	96	66.0
057106-LS	6-63	M63x1.5	15	2 1/2 2 1/2	21/30	49.0	56.0	54.6	65.9	147.0	0.40	2.50	85	96	66.0
057177-LS	7s-75s	M75x1.5	15	2 1/2 3	30/32	56.0	59.0	59.0	72.5	149.0	0.40	3.15	96	108	72.0
057107-LS	7-75	M75x1.5	15	2 1/2 3	30/32	59.0	66.0	65.0	78.0	149.0	0.40	3.15	96	108	72.0
057108-LS	8-80	M80x2.0	20	3	32	66.0	73.0	65.0	77.5	195.0	0.40	3.15	96	108	80.0
057199-LS	9s-90s	M90x2.0	20	3 3/4 3 3/4	32/33	73.0	79.0	73.0	86.5	204.0	0.40	3.50	111	125	89.0
057109-LS	9-90	M90x2.0	20	3 3/4 3 3/4	32/33	78.0	88.0	82.0	91.0	204.0	0.40	3.50	111	125	89.0
057110-LS	10-100	M100x2.0	20	3 1/2 4	33/34	86.0	96.0	90.0	100.0	209.0	0.40	3.50	125	141	98.0

All dimensions except NPT are in mm. Intermediate thread sizes are available on request. Precise measurements of the cable lead sheath are required prior to placing an order.

E1EX-U LEAD SEAL

ENCLOSURES AND EQUIPMENT TO WHICH CABLE GLANDS ARE FITTED:-

- Must be made from materials which are compatible with the cable gland materials.
- Have a sealing area around the cable gland entry point with a surface roughness <math>< Ra 6.3 \mu m</math>.
- Have entries that are perpendicular to the enclosure face in the area where the cable gland will seal to within 2.5°.
- Are sealed using the supplied sealing gasket (parallel threads) or by fully tightening into a threaded entry (tapered threads). Note that for tapered threads the IP rating can be improved to IP68 with the use of a suitable thread sealant.

MUST HAVE THREADED ENTRIES

- The same thread size as the cable gland. (Thread adapters should be used to correct

any mismatch).

- With a thread tolerance of metric class '6H' or equivalent.
- Where the thread length is a minimum of 10mm for Ex d applications or 3mm for all other applications

OR CLEARANCE HOLES (not Ex d)

- Where the hole size is the thread nominal size with a tolerance of +0.1 to +0.7mm. (e.g. the clearance hole for an M20 thread will have a diameter between 20.1mm and 20.7mm).
- Through material that is between 1mm and 12mm thick. (Thicker materials can be accommodated using glands with extended entry threads.)

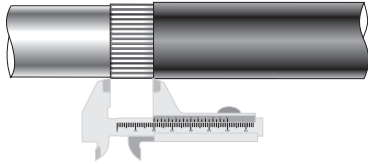

Gland Size	Armour Length	Gland Size	Armour Length	Gland Size	Armour Length
00-16ss	20.0	3-32	30.0	6m-63m	45.0
00-20ss	20.0	4s-40s	30.0	6L-63L	45.0
0-20s	20.0	4-40	30.0	7s-75s	50.0
1-20	25.0	5s-50s	35.0	7m-75m	50.0
2-25	25.0	5-50	35.0	7L-75L	50.0
3s-32s	30.0	6s-63s	45.0		

1. Cut back the cable outer sheath to expose the armour to a length as per the table above. Cut back the inner sheath to just before the armouring to expose lead sheath.

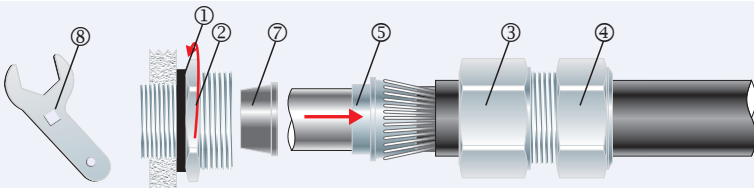

If the gland has NPT entry threads fitted to a threaded entry then IP68 (2m) can be achieved by applying one of the following tested and approved grease types to the thread: Renolit Lubrene CA700 or LX220 EP2, Renolit LC-WP2 or Moly LX2, or Dow Corning 4 Electrical Compound.

2. To maintain IP66/68, ensure the gasket ① is in place. Screw the gland unit onto the apparatus. Tighten the inner ② to installation torque using a CCG Spanner ⑧. Pass the cable end through the outer nut ④ and the body ③ over the cable. Splay the armour wires over the cone ⑤. Pass the lead seal ⑦ over the lead sheath.

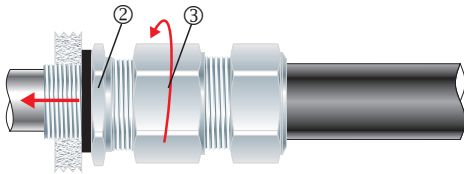

Alternative installation through an unthreaded entry.

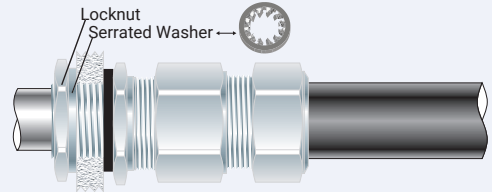

If the apparatus is untapped use a locknut.

3. Pass the cable end through the inner ② and tighten the body ③ onto the inner ② to lock the armour between the cone ⑤ and the cone ring ⑥.

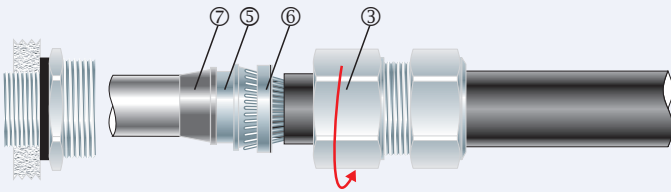

4. Unscrew the body ③ and check that lead seal ⑦ has bonded onto the lead of the cable (lead seal must be tight). Check that the armour has locked between the cone ⑤ and the cone ring ⑥ (O-Ring on the cone ring ⑥ is sacrificial).

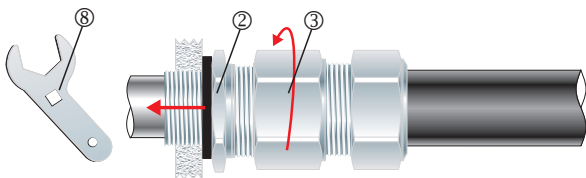

5. Pass the cable end through the inner ② and tighten the body ③ onto the inner ② to the installation torque using a CCG Spanner ⑧.

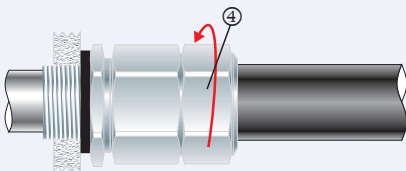

6. Tighten the outer nut ④ to produce a moisture proof seal by turning until the seal makes contact with outer sheath of cable and then make one full turn.