

CX/Z INSULATED

CAPTIVE COMPONENT GLAND®

for Braided and Steel Tape Cable



Features and Benefits

- For indoor and outdoor use.
- Gland is insulated from equipment to prevent system circulating currents.
- Freely rotating captive cone and inspectible cone ring, providing an armour clamp and earth bond without twisting the armouring.
- Patented disconnect armoured clamp system for ease of inspection.
- Provides a seal on the outer sheath of the cable sealing to IP65/66.
- Precision manufactured from high-quality brass (nickel plated), available in aluminium or stainless steel 316/316L on request.
- Complete with a heavy-duty (nickel-plated) locknut.



Technical Data

Type:	CX/Z Insulated		
Gland Material:	Brass (Nickel Plated) BS 2874, EN 12164, Aluminium ASTM BS221 Stainless Steel 316/316L		
Seal Material:	Thermoset Elastomer		
Cable Type:	Braid, Steel Tape Armour		
Armour Clamping:	Rotating Captive Cone and Inspectible Cone Ring		
Sealing Area:	Outer Sheath		
Optional Accessories:	Adaptor, Reducer, Earth Tag, Locknut, Serrated Washer and Shroud		
Standards and Certifications			
Mechanical Properties:	Impact Category 8 Anchorage Type C		
Continuous Operating Temp:	-65°C to +120°C		
Conformance:	Standard:	Certificate:	
Design Standards	BS 6121:Part 1	CML 14CA364	
	IEC/BS EN 62444	CML 14CA364	
	SANS 62444	MASC 22-9012	
	SANS 1213	MASC 18-2047, SANS 2109/4596	
IP66 - Parallel	IEC 60529	MASC 22-9015	
Marine ABS	IEC 62444	ABS 20-SG1952694-PDA	
DNV-GL	IEC 60529, BS 6121, IEC 62444	DNV-GL TAE000000Z	
London Underground Approval	BS EN 62444	LU 3043	

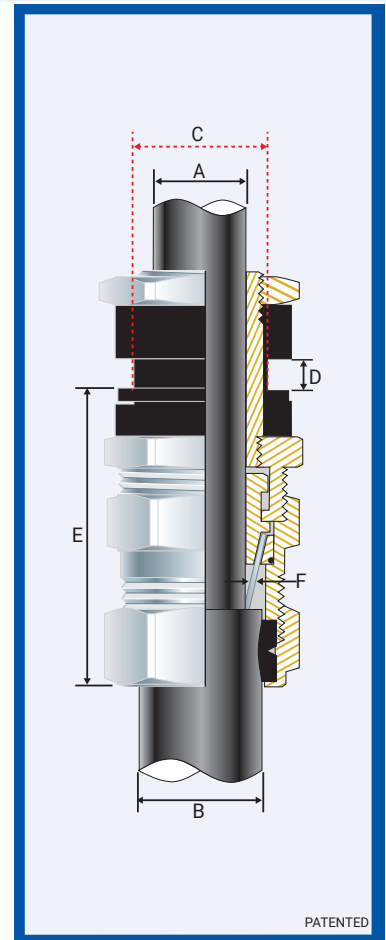

Installation Standards

- AS/NZS 3000
- BS 7430
- BS 6121-5
- IEC 60364-5-54
- BS 7671
- SANS 0142

Product Code	Gland Size Reference	Metric Entry Thread		NPT Entry Thread		Cable Detail			Max Length	Braid/STA Thickness		Hexagonal Detail		Installation Torque Value Nm	
		'C'	Min 'D'	'C'	Min 'D'	Max 'A'	Min 'B'	Max 'B'		Min 'F'	Max 'F'	Max 'Flats'	Max 'Crns'		
057600	00-20ss	M20x1.5	10	1/2	3/4	15	8.0	8.0	13.5	60.0	0.2	0.85	24.0	27.0	35.0
0576-0	0-20s	M20x1.5	10	1/2	3/4	15	12.0	11.5	16.0	65.0	0.2	0.90	24.0	27.0	35.0
057601	1-20	M20x1.5	10	1/2	3/4	15	13.5	14.5	20.5	65.0	0.2	1.25	27.0	30.0	35.0
057622	2s-25s	M25x1.5	10	3/4	1	15/19	17.5	16.0	24.5	75.0	0.2	1.25	35.0	39.0	50.0
057602	2-25	M25x1.5	10	3/4	1	15/19	17.5	20.5	26.5	75.0	0.2	1.25	35.0	39.0	50.0
057633	3s-32s	M32x1.5	10	1	1 1/4	19	24.0	23.0	30.5	80.0	0.2	1.40	42.0	47.0	70.0
057603	3-32	M32x1.5	10	1	1 1/4	19	24.0	26.5	33.5	80.0	0.2	1.40	42.0	47.0	70.0
057644	4s-40s	M40x1.5	15	1 1/4	1 1/2	19/21	34.0	30.0	39.5	85.0	0.3	1.40	52.0	59.0	90.0
057604	4-40	M40x1.5	15	1 1/4	1 1/2	19/21	34.0	33.0	42.5	85.0	0.3	1.40	52.0	59.0	90.0
057655	5s-50s	M50x1.5	15	1 1/2	2	21	42.5	34.0	47.5	95.0	0.4	1.40	65.0	73.0	100.0
057605	5-50	M50x1.5	15	1 1/2	2	21	42.5	42.5	52.5	95.0	0.4	1.40	65.0	73.0	100.0
057666	6s-63s	M63x1.5	15	2	2 1/2	21/30	55.5	45.5	60.5	105.0	0.4	1.50	80.0	90.0	120.0
057606	6-63	M63x1.5	15	2	2 1/2	21/30	55.5	52.5	65.5	105.0	0.4	1.50	80.0	90.0	120.0
057677	7s-75s	M75x1.5	15	2 1/2	3	30/32	68.0	57.0	72.5	115.0	0.4	1.50	96.0	108.0	120.0
057607	7-75	M75x1.5	15	2 1/2	3	30/32	68.0	65.5	78.0	115.0	0.4	1.50	96.0	108.0	120.0
057688	8s-80s	M80x2.0	20	3	3	32	72.5	65.0	77.5	120.0	2.5	1.60	96.0	108.0	120.0
057608	8-80	M80x2.0	20	3	3	32	72.5	77.5	82.0	120.0	2.5	1.60	96.0	108.0	120.0
057699	9s-90s	M90x2.0	20	3	3 1/2	32/33	82.0	73.0	86.5	150.0	3.0	1.60	110.0	124.0	120.0
057609	9-90	M90x2.0	20	3	3 1/2	32/33	81.5	82.0	91.0	15.0	3.0	1.60	110.0	124.0	120.0

All dimensions except NPT are in mm.

• When manufactured in Aluminium, Hex will be 27 Across Flats and 30 Across Corners.

CCG reserves the right to make alterations to the technical data, dimensions, designs and products available without notice. The illustrations cannot be considered binding. Please contact CCG for assistance.

CXZINS-PEG080329E

CX/Z INSULATED CAPTIVE COMPONENT GLAND®

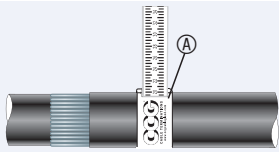

1. For accurate sizing, use a CCG Dimension Tape [Ⓐ] on the inner and outer cable sheath.

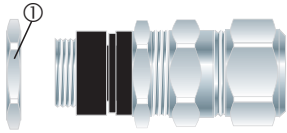

2. Remove the locknut [Ⓛ].

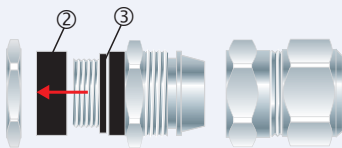

3. Remove the female insulator ring [Ⓜ]. To maintain IP66/68 rating ensure the gasket [Ⓝ] is in place.

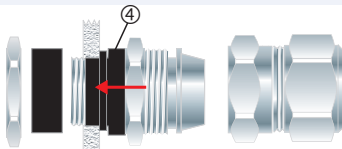

4. Insert the male insulator entry [Ⓞ] into the cable entry of the apparatus.

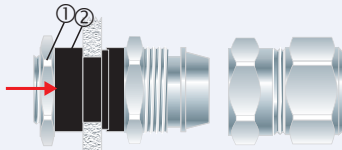

5. Screw the female insulator ring [Ⓜ] back against the apparatus (maximum of 10mm thickness). Screw the locknut [Ⓛ] back against the female insulator ring [Ⓜ].

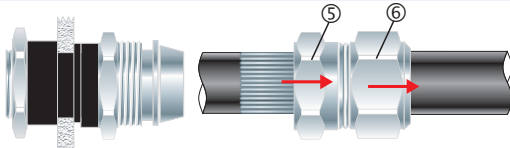

6. Strip the cable outer sheath and pass the outer nut [Ⓠ] and the body [Ⓟ] over the cable.

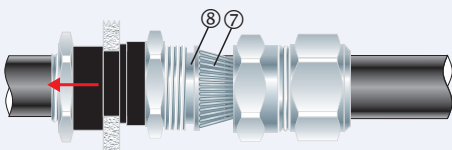

7. Pass the cable end through the inner and splay the armour wires [Ⓡ] over the cone [Ⓢ].

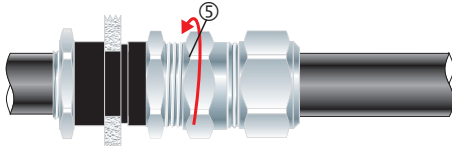

8. Tighten the body [Ⓟ] onto the inner to lock the armour between the cone [Ⓢ] and cone ring [Ⓣ].

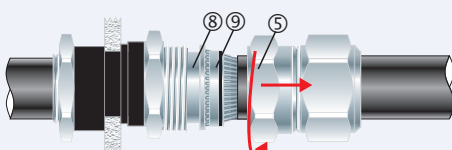

9. Unscrew the body [Ⓟ]. Check that the armour has locked between the cone [Ⓢ] and cone ring [Ⓣ]. (O-Ring on the cone ring [Ⓣ] is sacrificial).

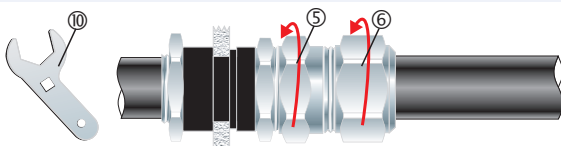

10. Tighten the body [Ⓟ] onto the inner using a CCG Spanner ^⓫. Tighten the outer nut [Ⓠ] to produce a moisture-proof seal by turning until the seal makes contact with the outer sheath of cable and make one full turn.