



CW INTEGRAL EARTH CAPTIVE COMPONENT GLAND®

for Steel Wire and Aluminium Armoured Cable

Features and Benefits

- For indoor and outdoor use.
- Includes an integral earth connection for HV system circuits where high earth fault currents may be experienced.
- Two-piece handling, no loose parts.
- Freely rotating captive cone and inspectible cone ring, providing an armour clamp and earth bond without twisting the armouring.
- Patented disconnect armoured clamp system for ease of inspection
- Provides a seal on the outer sheath of the cable sealing to IP65/66.
- Precision manufactured from high-quality Brass (nickel plated), available in Aluminium or Stainless Steel 316/316L on request.
- Complete with a thread sealing gasket, earthing stud, a bolt and a heavy-duty locknut.



Technical Data

Type:	CW IE (Integral Earth)
Gland Material:	Brass (Nickel Plated), BS 2874, EN 12164, Aluminium ASTM B221, Stainless Steel 316/316L
Seal Material:	Thermoset Elastomer or Silicone on request
Cable Type:	Steel Wire Armour and Aluminium Armour Wire
Armour Clamping:	Rotating Captive Cone and Inspectible Cone Ring
Sealing Area:	Outer Sheath
Optional Accessories:	Adaptor, Reducer, Locknut, Serrated Washer and Shroud

Standards and Certifications

Mechanical Properties:	Impact Category 8 Anchorage Type D
Electrical Properties:	Category C
Current Rating:	BS 6121:Part 5, IEC 62444 Size 20s to 40 26kA one second Size 50s and above 43kA one second
Continuous Operating Temp:	-65°C to +120°C
Conformance:	Standard: Certificate: Design Standards BS 6121:Part 1 CML 14CA364 IEC/BS EN 62444 CML 14CA364 SANS 62444 MASC 22-9012 SANS 1213 MASC 26-9013, SANS 2109/4596 IEC 60529 MASC 22-9015 IP66 - Parallel IEC 60529, IEC 62444 25-0167207-PDA IP65 - Tapered IEC 60529, BS 6121, IEC 62444 TAE000000Z Marine ABS DNV IEC 60529, IEC 62444 EN 55011, + A1, EN 55022 SGS EMC305079/1 EMC Compatible EN 55011, + A1, EN 55022 LU 3043 London Underground Approval BS EN 62444

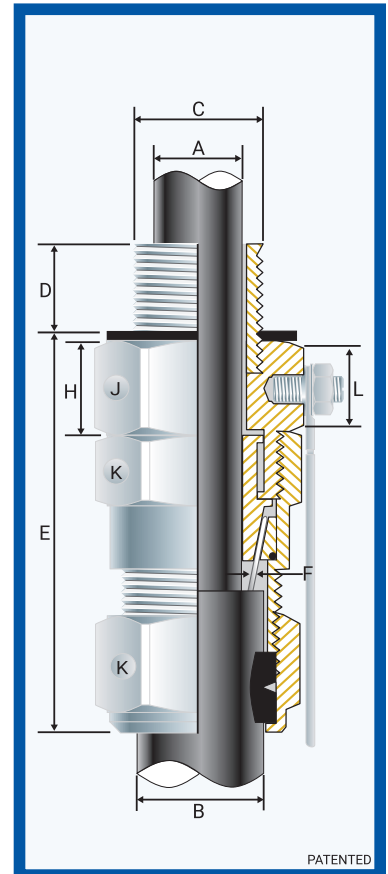

Installation Standards

- AS/NZS 3000
- BS 7671
- IEC 60364-5-54
- BS 6121-5
- BS 7430
- SANS 0142

Product Code	Gland Size Ref	Metric Entry Thread		NPT Entry Thread		Cable Detail			Max Length 'E'	Armour Dia		Hexagonal Detail				Earth Bolt 'L'	Install. Torque Nm	
		'C'	Min 'D'	'C'	Min 'D'	Max 'A'	Min 'B'	Max 'B'		Min 'F'	Max 'F'	Flats 'J'	Crns 'J'	Flats 'K'	Crns 'K'			Thick 'H'
051100*	00-20ss	M20x1.5	10	1/2/3/4	15	8.5	8.0	13.5	60.0	0.90	0.90	♦24.0	♦27.0	♦24.0	♦27.0	15.0	M6/M8	35.0
0511-0*	0-20s	M20x1.5	10	1/2/3/4	15	12.0	11.5	16.0	60.0	0.90	1.25	♦24.0	♦27.0	♦24.0	♦27.0	15.0	M6/M8	35.0
051101	1-20	M20x1.5	10	1/2/3/4	15	15.0	14.5	20.5	63.0	0.90	1.25	27.0	30.0	27.0	30.0	15.0	M6/M8	35.0
051122	2s-25s	M25x1.5	10	3/4/1	15/19	17.5	16.0	24.5	70.0	1.25	1.60	42.0	47.0	35.0	39.0	15.0	M8/M10	50.0
051102	2-25	M25x1.5	10	3/4/1	15/19	20.0	20.5	26.5	70.0	1.25	1.60	42.0	47.0	35.0	39.0	15.0	M8/M10	50.0
051133	3s-32s	M32x1.5	10	1/1 1/4	19	22.0	23.0	30.5	76.0	1.60	2.00	50.0	56.0	42.0	47.0	20.0	M12	70.0
051103	3-32	M32x1.5	10	1/1 1/4	19	26.5	26.5	33.5	76.0	1.60	2.00	50.0	56.0	42.0	47.0	20.0	M12	70.0
051144	4s-40	M40x1.5	15	1 1/4/1 1/2	19/21	31.5	30.0	39.5	93.0	1.60	2.00	52.0	59.0	52.0	59.0	20.0	M12	90.0
051104	4-40	M40x1.5	15	1 1/4/1 1/2	19/21	34.0	33.0	42.5	93.0	1.60	2.00	52.0	59.0	52.0	59.0	20.0	M12	90.0
051155	5s-50s	M50x1.5	15	1 1/2/2	21	38.0	34.0	47.5	102.0	2.00	2.50	65.0	73.0	65.0	73.0	22.0	M12	100.0
051105	5-50	M50x1.5	15	1 1/2/2	21	38/44.5	42.5	52.5	102.0	2.00	2.50	65.0	73.0	65.0	73.0	22.0	M12	100.0
051166	6s-63s	M63x1.5	15	2/2 1/2	21/30	50.0	45.5	60.5	130.0	2.00	2.50	80.0	90.0	86.0	97.0	25.0	M12	120.0
051106	6-63	M63x1.5	15	2/2 1/2	21/30	56.5	52.5	65.5	130.0	2.00	2.50	80.0	90.0	86.0	97.0	25.0	M12	120.0
051177	7s-75s	M75x1.5	15	2 1/2/3	30/32	62.0	57.0	72.5	138.0	2.50	3.15	111.0	125.0	96.0	102.0	25.0	M12	120.0
051107	7-75	M75x1.5	15	2 1/2/3	30/32	62/67.5	65.5	78.0	138.0	2.50	3.15	111.0	125.0	96.0	102.0	25.0	M12	120.0
051188	8s-80s	M80x2.0	20	3	32	69.0	65.0	77.5	195.0	2.50	3.15	111.0	125.0	96.0	102.0	25.0	M12	120.0
051108	8-80	M80x2.0	20	3/3 1/2	32/33	74.0	78.0	82.0	195.0	2.50	3.20	111.0	125.0	96.0	102.0	25.0	M12	120.0
051199	9s-90s	M90x2.0	20	3/3 1/2	32/33	75.0	73.0	86.5	204.0	3.00	3.50	111.0	125.0	111.0	125.0	40.0	M12	120.0
051109	9-90	M90x2.0	20	3/3 1/2	32/33	81.5	82.0	91.0	204.0	3.00	3.50	111.0	125.0	111.0	125.0	40.0	M12	120.0
051110	10-100	M100x2.0	20	3 1/2/4	33/34	91.0	90.0	100.0	209.0	3.00	3.50	125.0	141.0	125.0	141.0	40.0	M12	120.0
051111	11-110	M110x2.0	20	4	34	98.0	100.0	114.0	209.0	3.00	4.00	135.0	152.0	135.0	152.0	40.0	M12	120.0

All dimensions except NPT are in mm. * Customers to specify M6 or M8.

• When manufactured in Aluminium, Hex will be 27 Across Flats and 30 Across Corners.

CW INTEGRAL EARTH GLAND

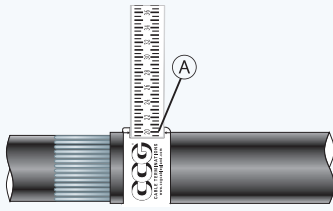

1. For accurate sizing, use a CCG Dimension Tape (A) on the inner and outer cable sheath.

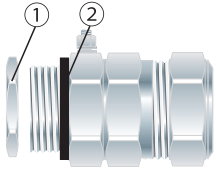

2. Remove the locknut (1). To maintain IP66 ensure the gasket (2) is in place.

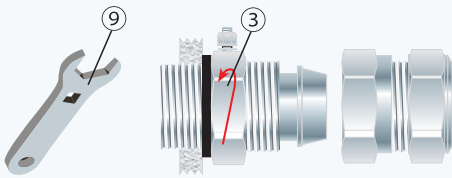

3. Screw the inner (3) into the apparatus. Tighten the inner (3) to installation torque using a CCG Spanner (9).

Alternative installation through an unthreaded entry.

If the apparatus is untapped use a locknut.

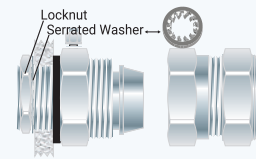

If the gland has NPT entries fitted to a threaded entry then IP68 (2m) can be achieved by applying one of the following tested and approved grease types to the thread:- Renolit Lubrene CA700 or LX220 EP2, Renolit LC-WP2 or Moly LX2, or Dow Corning 4 Electrical Compound.

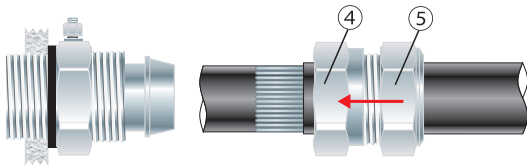

4. Cut back the cable outer sheath and pass the outer nut (5) and the body (4) over the cable.

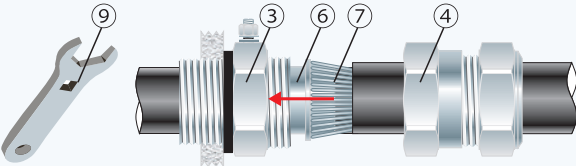

5. Pass the cable end through the inner (3). Splay the armour wires (7) over the cone (6). Tighten the body (4) onto the inner (3) until hand tight, then tighten with a CCG Spanner (7) with $\frac{3}{4}$ turn to lock the armour between the cone (6) and the cone ring (8).

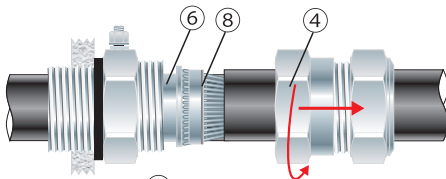

6. Unscrew the body (4). Check that the armour has locked between the cone (6) and cone ring (8) (O-Rings on the cone (6) and cone ring (8) are sacrificial).

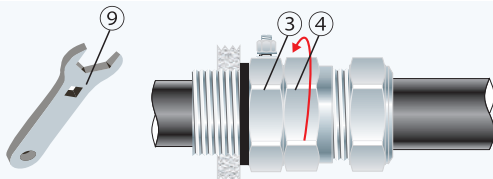

7. Tighten the body (4) onto the inner (3) to installation torque using a CCG Spanner (9).

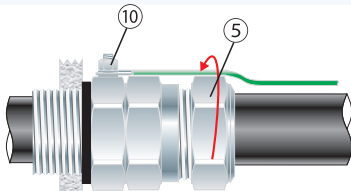

8. Tighten the outer nut (5) to produce a moisture proof seal by turning until the seal makes contact with the outer sheath of cable and then make one full turn. Connect earth wire / lug to earth stud (10).