

E1X/Z

CAPTIVE COMPONENT GLAND®

for Braid and Steel Tape Armour Cable



Features and Benefits

- For indoor and outdoor use.
- Two piece handling, no loose parts.
- Freely rotating captive cone and inspectible cone ring, providing an armour clamp and earth bond without twisting the armouring.
- Patented disconnect armoured clamp system for ease of inspection.
- Provides a seal on the inner and outer sheath of the cable sealing to IP65/66/68.
- Precision manufactured from high-quality brass (nickel plated) available in aluminium and stainless steel 316/316L on request.
- Complete with thread sealing gasket and heavy duty locknut.



Technical Data

Type:	E1X/Z
Gland Material:	Brass (Nickel Plated) BS 2874, EN 12164, Aluminium ASTM BS221, Stainless Steel 316/316L
Seal Material:	Thermoset Elastomer
Cable Type:	Braid, Steel Tape Armour
Armour Clamping:	Rotating Captive Cone and Inspectible Cone Ring
Sealing Area:	Inner Sheath and Outer Sheath
Optional Accessories:	Adaptor, Reducer, Earth Tag, Locknut, Serrated Washer and Shroud

Standards and Certifications

Mechanical Properties:	Impact Category 8 Anchorage Type C	
Electrical Properties:	Category A (no earth tag) Category B (with earth tag)	
Continuous Operating Temp:	-65°C to +120°C	
Conformance:	Standard:	Certificate:
Design Standards	BS 6121:Part 1	CML 14CA364
	EN 50262	CML 14CA364
	IEC/BS EN 62444	CML 14CA364
	SANS 62444	MASC 11-303
	SANS 1213	MASC 18-2047, SANS 2109/4596
IP66/68 100m - Parallel	IEC 60529	CML 15Y728
IP65 - Tapered	IEC 60529	
Marine ABS	IEC 62444	ABS 20-SG1952694-PDA
	DNV-GL	IEC 60529, BS 6121, IEC 62444
EMC Compatible	EN 55011:2009 + A1:2010,	SGS EMC197708/1
	EN 55022:2010	
London Underground Approval	BS EN 62444	LU 3043

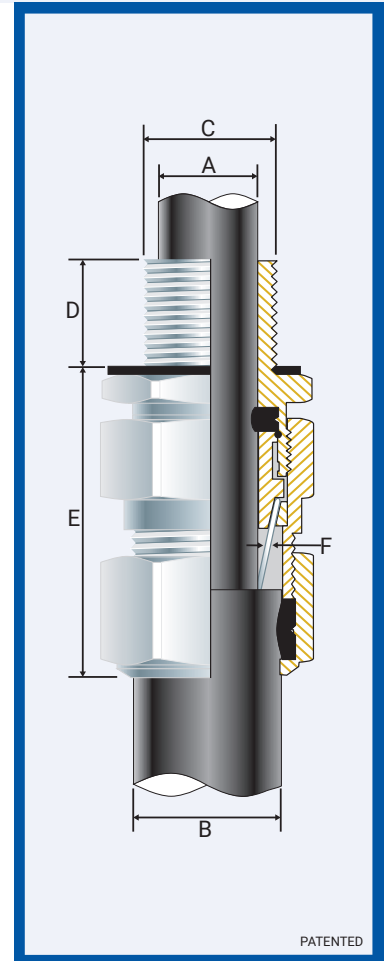

Installation Standards

- AS/NZS 3000
- BS 6121-5
- BS 7671
- BS 7430
- IEC 60364-5-54
- SANS 0142

Product Code	Gland Size Reference	Metric Entry Thread		NPT Entry Thread		Cable Detail				Max Length 'E'	Hexagonal Detail		Braid/STA Thickness Max	Install Torque Nm
		'C'	Min 'D'	'C'	Min 'D'	Min 'A'	Max 'A'	Min 'B'	Max 'B'		Max 'Flats'	Max 'Crns'		
051700	00-20ss	M20x1.5	10	½	15	3.0	8.0	8.0	13.5	50.0	♦ 24.0	♦ 27.0	0.85	35.0
0517-0	0-20s	M20x1.5	10	½	15	7.0	12.0	11.5	16.0	50.0	♦ 24.0	♦ 27.0	0.85	35.0
051701	1-20	M20x1.5	10	½/¾	15	9.0	15.0	14.5	20.5	57.0	27.0	30.0	0.90	35.0
051722	2s-25s	M25x1.5	10	¾/1	15/19	11.0	17.5	16.0	24.5	60.0	35.0	39.0	1.25	50.0
051702	2-25	M25x1.5	10	¾/1	15/19	14.0	20.0	20.5	26.5	60.0	35.0	39.0	1.25	50.0
051733	3s-32s	M32x1.5	10	1/1¼	19	15.0	22.0	23.0	30.5	65.0	42.0	47.0	1.40	70.0
051703	3-32	M32x1.5	10	1/1¼	19	19.0	26.5	26.5	33.5	65.0	42.0	47.0	1.40	70.0
051744	4s-40s	M40x1.5	15	1¼/1½	19/21	22.0	31.5	30.0	39.5	78.0	52.0	59.0	1.40	90.0
051704	4-40	M40x1.5	15	1¼/1½	19/21	26.0	34.0	33.0	42.5	78.0	52.0	59.0	1.40	90.0
051755	5s-50s	M50x1.5	15	1½/2	21	29.0	38.0	34.0	47.5	101.0	65.0	73.0	1.40	100.0
051705	5-50	M50x1.5	15	1½/2	21	34.0	44.5	42.5	52.5	101.0	65.0	73.0	1.40	100.0
051766	6s-63s	M63x1.5	15	2/2½	30	38.0	50.0	45.5	60.5	125.0	80.0	90.0	1.50	120.0
051706	6-63	M63x1.5	15	2/2½	30	44.0	56.5	52.5	65.5	125.0	80.0	90.0	1.50	120.0
051777	7s-75s	M75x1.5	15	2½/3	32	50.0	62.0	57.0	72.5	130.0	96.0	108.0	1.50	120.0
051707	7-75	M75x1.5	15	2½/3	32	56.0	67.5	65.5	78.0	130.0	96.0	108.0	1.50	120.0
051788	8s-80s	M80x2.0	20	3	32	59.0	69.0	65.0	77.5	120.0	96.0	108.0	1.50	120.0
051708	8-80	M80x2.0	20	3	32	68.0	74.0	78.0	82.0	120.0	96.0	108.0	1.60	120.0
051799	9s-90s	M90x2.0	20	3/3½	32/33	66.0	75.0	73.0	86.5	140.0	111.0	125.0	1.60	120.0
051709	9-90	M90x2.0	20	3/3½	32/33	74.0	81.5	82.0	91.0	140.0	111.0	125.0	1.60	120.0

All dimensions except NPT are in mm.

* When manufactured in Aluminium, Hex will be 27 Across Flats and 30 Across Corners.

CCG reserves the right to make alterations to the technical data, dimensions, designs and products available without notice. The illustrations cannot be considered binding. Please contact CCG for assistance.

E1XZ-EMC200820E

E1X/Z CAPTIVE COMPONENT GLAND®

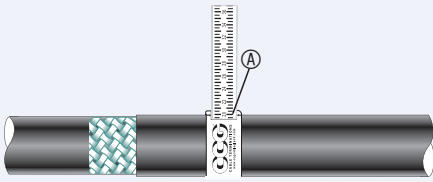

1. For accurate sizing, use a CCG Dimension Tape **(A)** on the inner and outer cable sheath.

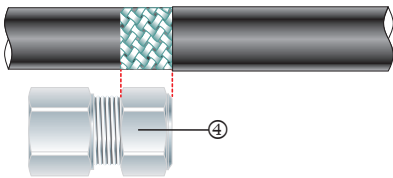

2. Cut back the cable outer sheath to expose the braid to a length not more than the outer nut **(4)**.

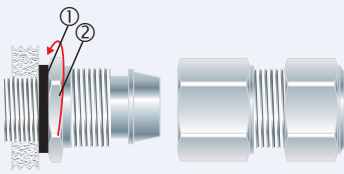

3. To maintain IP66/68 ensure the gasket **(1)** is in place. Tighten the inner **(2)** into the apparatus.

Alternative installation through an unthreaded entry.

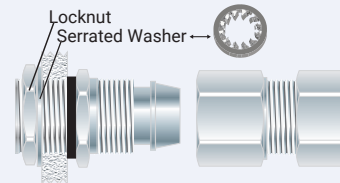

If the apparatus is untapped use a locknut.

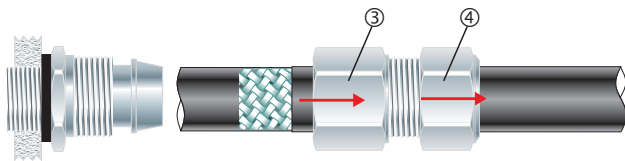

4. Pass the outer nut **(4)** and the body **(3)** over the cable.

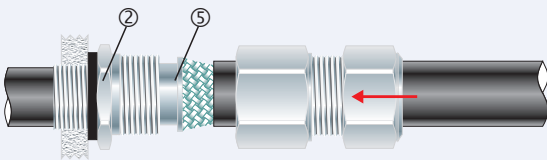

5. Pass the cable end through the inner **(2)**. Splay the braiding over the cone **(5)**.

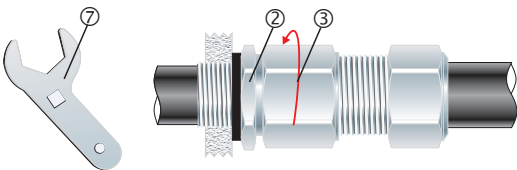

6. Tighten the body **(3)** onto the inner **(2)** until hand tight, then tighten with a CCG Spanner **(7)** with $\frac{3}{4}$ turn to lock the braid between the cone **(5)** and the cone ring **(6)**.

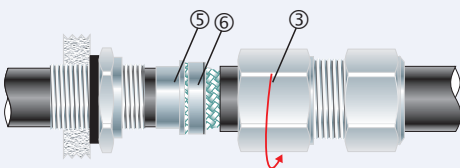

7. Unscrew the body **(3)**. Check that the braid has locked between the cone **(5)** and the cone ring **(6)**. (O-Ring on the cone ring **(6)** is sacrificial).

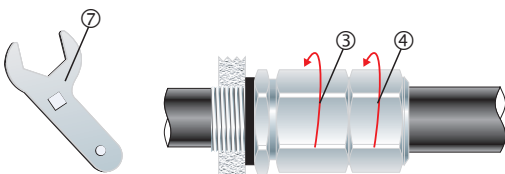

8. Tighten the body **(3)** onto the inner to the installation torque. Tighten the outer nut **(4)** to produce a moisture proof seal by turning until the seal makes contact with outer sheath of cable and then make one full turn.