

D1W

CAPTIVE COMPONENT GLAND®

for SWA and Aluminium Armoured Cable



Features and Benefits

- For indoor and outdoor use when fitted with a shroud.
- Two piece handling, no loose parts.
- Freely rotating captive cone and inspectible cone ring, providing an armour clamp and earth bond without twisting the armour wire.
- Factory fitted captive elastomeric inner seal for ingress protection IP66/68.
- Seals on the inner sheath of the cable.
- Precision manufactured from high-quality brass (nickel plated) available in aluminium on request.
- Complete with thread sealing gasket and heavy duty locknut.



Technical Data

Type:	D1W
Gland Material:	Brass (Nickel Plated) BS 2874, EN 12164, Aluminium ASTM B221
Seal Material:	Thermoset Elastomer or Silicone on request
Cable Type:	Steel Wire Armour and Aluminium Armour Wire
Armour Clamping:	Rotating Captive Cone and Inspectible Cone Ring
Sealing Area:	Inner Sheath
Optional Accessories	Adaptor, Reducer, Earth Tag, Locknut, Serrated Washer and Shroud

Standards and Certifications

Mechanical Properties:	Impact Category 8 Anchorage Type D	
Electrical Properties:	Category A (no earth tag) Category B (with earth tag)	
Continuous Operating Temp:	-65°C to +120°C	
Conformance:	Standard:	Certification:
Design Standards	BS 6121:Part 1	CML 14CA364
	EN 50262	CML 14CA364
	IEC/BS EN 62444	CML 14CA364
	SANS 62444	MASC 11-303
	SANS 1213	MASC 18-2047, SANS 2109/4596
IP66/68 - Parallel	IEC 60529	MASC 11-263
EMC Compatible	EN 55011:2009 + A1:2010,	SGS EMC197708/1
	EN 55022:2010	
London Underground Approval	BS EN 62444	LU 3043

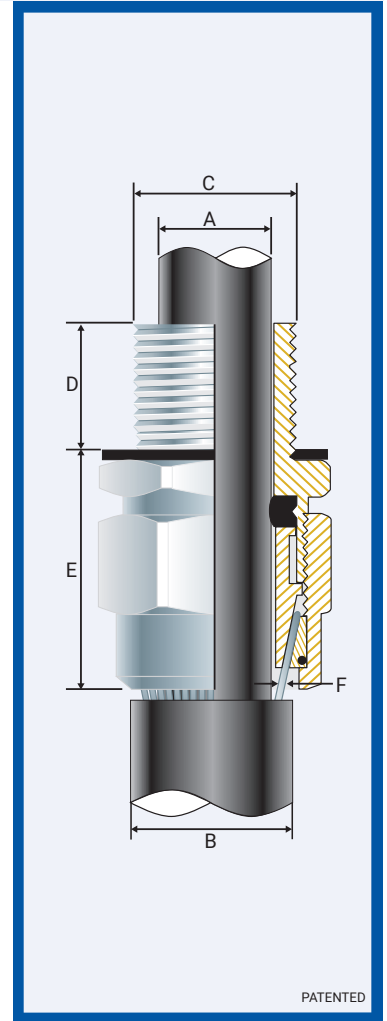

PATENTED



Installation Standards

- AS/NZS 3000
- BS 6121-5
- BS 7671
- BS 7430
- IEC 60364-5-54
- SANS 0142

Product Code	Gland Size Reference	Metric Entry Thread		NPT Entry Thread		Cable Detail			Max Length 'E'	Armour Dia		Hexagonal Detail		Install Torque Value Nm
		'C'	Min 'D'	'C'	Min 'D'	Min 'A'	Max 'A'	Max 'B'		Min 'F'	Max 'F'	Max 'Flats'	Max 'Crns'	
052000-16	00-16ss	M16x1.5	10	-	-	3.0	8.5	13.5	32.0	0.90	0.90	▲▲ 24.0	◆ 27.0	35.0
052000	00-20ss	M20x1.5	10	½	15	3.0	8.5	13.5	32.0	0.90	0.90	▲▲ 24.0	◆ 27.0	35.0
0520-0	0-20s	M20x1.5	10	½	15	8.0	12.0	16.0	32.0	0.90	1.25	▲▲ 24.0	◆ 27.0	35.0
052001	1-20	M20x1.5	10	½/¾	15	11.5	15.0	20.5	32.0	0.90	1.25	▲ 27.0	◆ 30.0	35.0
052002	2-25	M25x1.5	10	¾/1	15/19	15.0	20.0	26.5	35.0	1.25	1.60	▲ 35.0	◆ 39.0	50.0
052003	3-32	M32x1.5	10	1 1/4	19	20.0	26.5	33.5	35.0	1.60	2.00	▲ 42.0	◆ 47.0	70.0
052004	4-40	M40x1.5	15	1 ¼/1 ½	19/21	26.0	34.0	42.5	50.0	1.60	2.00	▲ 52.0	◆ 59.0	90.0
052005	5-50	M50x1.5	15	1 ½/2	21	34.0	44.5	52.5	53.0	2.00	2.50	▲ 65.0	◆ 73.0	100.0
052006	6-63	M63x1.5	15	2/2 ½	30	44.0	56.5	65.5	70.0	2.00	2.50	▲ 80.0	◆ 90.0	120.0
052007	7-75	M75x1.5	15	2 ½/3	32	56.0	67.5	78.0	78.0	2.50	3.15	▲ 96.0	◆ 108.0	120.0
052008	8-80	M80x2.0	20	3	32	68.0	74.0	82.0	78.0	2.50	3.15	▲ 96.0	◆ 108.0	120.0
052009	9-90	M90x2.0	20	3 ½/3	32/33	74.0	81.5	91.0	83.0	3.00	3.50	▲ 111.0	◆ 125.0	120.0
052010	10-100	M100x2.0	20	3 ¾/4	33/34	81.0	90.0	100.0	88.0	3.00	3.50	-	-	120.0
052011	11-110	M110x2.0	20	4	34	86.0	98.0	114.0	92.0	3.00	4.00	-	-	120.0
052012	12-120	M120x2.0	20	-	-	95.0	103.0	118.0	96.0	3.00	4.00	-	-	120.0
052013	13-130	M130x2.0	20	-	-	100.0	115.0	124.0	100.0	3.00	4.00	-	-	120.0

All dimensions are in mm.

▲ For use with CCG Hex-Spanner.

◆ When manufactured in Aluminium, Hex will be 27 Across Flats and 30 Across Corners.

CCG reserves the right to make alterations to the technical data, dimensions, designs and products available without notice. The illustrations cannot be considered binding. Please contact CCG for assistance.

D1W-IN200820

D1W CAPTIVE COMPONENT GLAND®

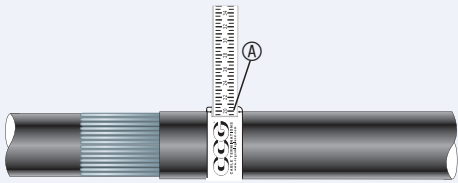

1. For accurate sizing, use a CCG Dimension Tape (A) on the inner and outer cable sheath.

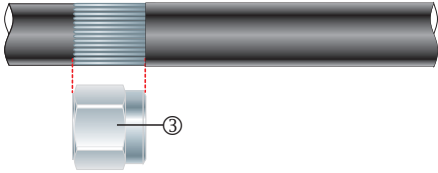

2. Cut back the cable outer sheath to expose the armour to a length not more than the outer (3).

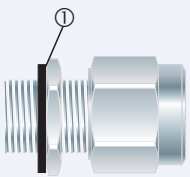

3. To maintain IP66/68 ensure the gasket (1) is in place.

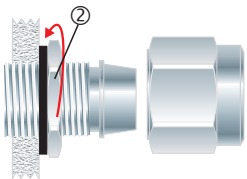

4. Screw the gland unit into the apparatus. Tighten the inner (2). If apparatus is untapped use a locknut.

Alternative installation through an unthreaded entry.

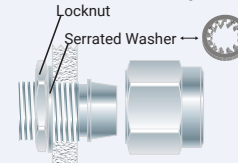

If the apparatus is untapped use a locknut.

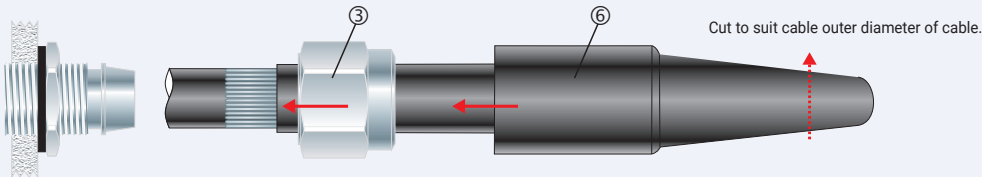

5. Cut the shroud to suit cable outer diameter of cable. Pass the cable end through the shroud (6) and the outer (3).

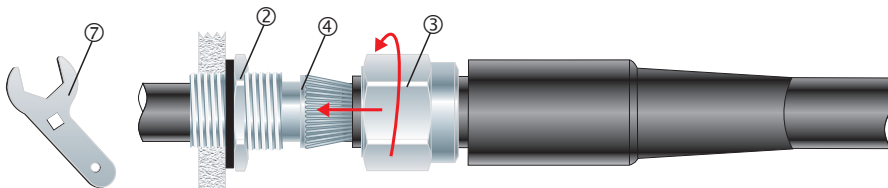

6. Pass the cable end through the inner (2). Splay armour wires over the cone (4). Tighten the outer (3) onto the inner (2) until hand tight, then tighten with a CCG Spanner (7) with $\frac{3}{4}$ turn to lock the armour between the cone (4) and the cone ring (5).

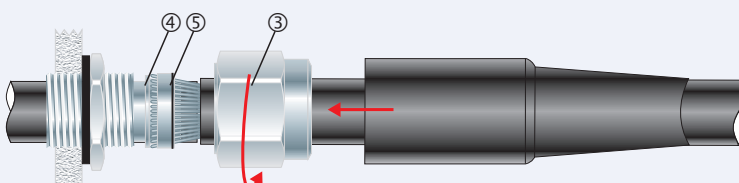

7. Unscrew the outer (3). Check that the armour has locked between the cone ring (5) and the cone (4). (O-Ring on the cone ring (5) is sacrificial).

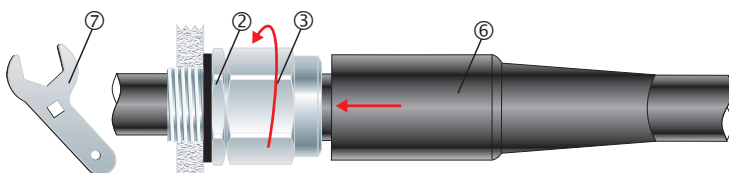

8. Tighten the outer (3) onto the inner (2) to installation torque using a CCG Spanner (7). Slide the shroud (6) over the gland.