



# E1EX

Ex db IIC, Ex eb IIC, Ex tb IIIC, Ex nR IIC

CAPTIVE COMPONENT GLAND® WITH VARIABLE DELUGE SEAL™ for Steel and Aluminium Armoured Cable

### Features and Benefits

- For indoors, outdoors, Group II, III, Zone 1, 2, 21 and 22 hazardous areas.
- Two part handling, no loose parts.
- Freely rotating captive cone and inspectible cone ring provides an armour clamp and earth bond on steel wire and aluminium armour.
- Patented disconnect system allows for inspection of armour clamp and inner seal after assembly.
- With a patented Variable Deluge Seal™ as standard.
- Factory fitted with a specially formulated elastomeric seal for Built-in Safety™, seals on the inner and outer sheath of the cable to IP65/66/68.
- Precision manufactured from high-quality brass (Marine Grade Electroless Nickel Plated™) available in aluminium or stainless steel 316/316L on request.
- Supplied with a thread sealing gasket (parallel threads only).



### Technical Data

Type:	E1EX
Gland Material:	Brass (Marine Grade Electroless Nickel Plated™), Aluminium, Stainless Steel 316/316L
Seal Material:	Standard Thermoset Elastomer or Extreme Temperature Seals
Sealing Gasket Material:	HDPE, Nylon 66 or PTFE
Cable Type:	Steel Wire Armour and Aluminium Armour
Armour Clamping:	Rotating Captive Cone and Inspectible Cone Ring
Sealing Area:	Inner Sheath, Outer Sheath and Variable Deluge Seal™
Optional Accessories:	Adaptor, Reducer, Earth Tag, Locknut, Serrated Washer and Shroud
Note:	The installer should ensure that the materials are suitable for the installation environment.

### Standards and Certifications

Equipment Protection Levels:	IECEX/INMETRO: Ex db IIC Gb, Ex eb IIC Gb, Ex nR IIC Gc, Ex tb IIIC Db ATEX/UKEX: Ex II 2GD, II 3G, Ex db IIC Gb, Ex eb IIC Gb, Ex nR IIC Gc, Ex tb IIIC Db TR CU: Ex I Ex d IIC Gb X / 1Ex e IIC Gb X / 2Ex nR IIC Gc X / Ex tb IIIC Db X	
Continuous Operating Temp:	Standard Seals: -60°C to +95°C/100°C (HDPE/ Nylon Sealing Gasket) Extreme Temp. Seals: -60°C to +160°C (PTFE Sealing Gasket)	
Conformance:	Standard: Certificate:	
IEC/BS EN	IEC/BS EN 62444, 6121	CML 14CA364
IECEX	IEC 60079 Part 0, 1, 7, 15, 31	IECEX CML 18.0018X
ATEX	EN 60079 Part 0, 1, 7, 31 EN 60079 Part 0, 15	CML 16ATEX1001X CML 16ATEX4002X
UKEX	BS EN 60079 Part 0, 1, 7, 31 BS EN 60079 Part 0, 15	CML 21UKEX1011X CML 21UKEX4006X
INMETRO (Brazil)	ABNT NBR IEC 60079 Part 0, 1, 7, 15, 31	TÜV 15.0483X
TR CU (Russia)	ГОСТ 31610-0, 15, ГОСТ IEC 60079-1 ГОСТ Р МЭК 60079-7, 31	EAЭC RU C-ZA.HA91.B.00245/21
CNEX (Chinese)	GB 3836.1, GB3936.2, GB3836.3 GB12476.1, GB12476.5	CNEX 21.3387X CNEX CCC 2021312313000396
SANS	SANS/IEC 60079 Part 0, 1, 7, 15, 31	MASC MS/13-028X CML 15Y728
IP66/68 100m - Parallel	IEC 60529	
IP65/66 - Tapered	IEC 60529	
IP68 - Tapered and approved grease	IEC 60529	IECEX CML 18.0018X CML 14CA370-2
Deluge Protection	DTS-01	EXOVA N968667
Corrosion Protection	ASTM B117-11, BS EN ISO 3231	ABS 20-1952706-1-PDA
Marine ABS	IEC 60079 Part 0, 1, 7, 15, 31 and IEC 60529	DNV-GL TAE0000010
DNV-GL	IEC 60079 Part 0, 1, 7 and IEC 60529	SGS EMC197708/1
EMC Compatible	EN 55011:2009, EN 55022:2010	

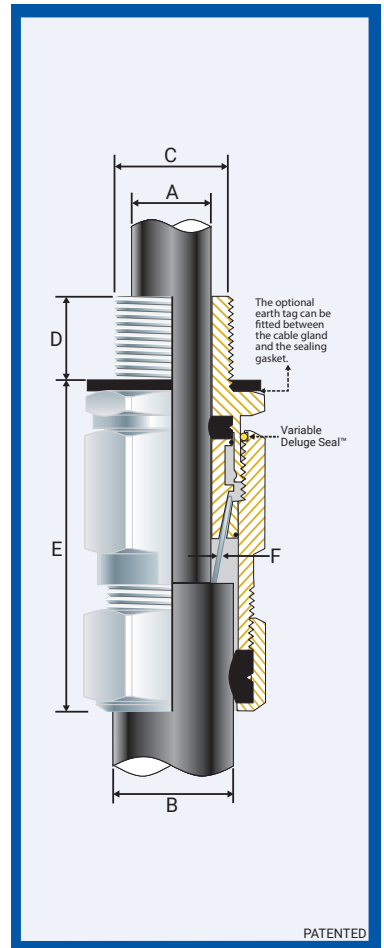

### Conditions for Safe Use - X

- The cable glands shall only be used where the temperature, at the point of entry, is between -60°C to +95°C (standard seals & HDPE sealing gaskets), -60°C to +100°C (standard seal and Nylon sealing gasket) or -60°C to +160°C (extreme temp. seal & PTFE sealing gasket) depending on seal and gasket used.
- Note: According to IEC 60079-14, 10.6.2: An Ex d gland will only maintain Ex d integrity when used with substantially round, compact and filled cable. If not a CCG VORTEX® or QuickStop-Ex® barrier gland should be used.

Product Code	Gland Size Reference	Metric Entry Thread		NPT Entry Thread		Cable Detail				Max Length 'E'	Armour Dia		Hexagonal Detail		Install. Torque Value Nm
		'C'	Min 'D'	'C'	Min 'D'	Min 'A'	Max 'A'	Min 'B'	Max 'B'		Min 'F'	Max 'F'	Max 'Flats'	Max 'Crns'	
052300-16	00-16ss	M16x1.5	15	-	-	3.0	8.5	8.0	13.5	60.0	0.90	0.90	24.0	27.0	21.0
052300	00-20ss	M20x1.5	15	1/2/3/4	15	3.0	8.5	8.0	13.5	60.0	0.90	0.90	24.0	27.0	21.0
0523-0	0-20s	M20x1.5	15	1/2/3/4	15	7.0	12.0	11.5	16.0	60.0	0.90	1.25	24.0	27.0	21.0
052301	1-20	M20x1.5	15	1/2/3/4	15	9.0	15.0	14.5	20.5	63.0	0.90	1.25	27.0	30.0	21.0
052322	2s-25s	M25x1.5	15	3/4/1	15/19	11.0	17.5	16.0	24.5	70.0	1.25	1.60	35.0	39.0	30.0
052302	2-25	M25x1.5	15	3/4/1	15/19	14.0	20.0	20.5	26.5	70.0	1.25	1.60	35.0	39.0	30.0
052333	3s-32s	M32x1.5	15	1/1 1/4	19	15.0	22.0	23.0	30.5	76.0	1.60	2.00	42.0	47.0	42.0
052303	3-32	M32x1.5	15	1/1 1/4	19	19.0	26.5	26.5	33.5	76.0	1.60	2.00	42.0	47.0	42.0
052344	4s-40s	M40x1.5	15	1 1/4/1 1/2	19/21	22.0	31.5	30.0	39.5	93.0	1.60	2.00	52.0	59.0	52.0
052304	4-40	M40x1.5	15	1 1/4/1 1/2	19/21	26.0	34.0	33.0	42.5	93.0	1.60	2.00	52.0	59.0	52.0
052355	5s-50s	M50x1.5	15	1 1/2/2	21	29.0	38.0	34.0	47.5	102.0	2.00	2.50	65.0	73.0	57.0
052305	5-50	M50x1.5	15	1 1/2/2	21	34.0	44.5	42.5	52.5	102.0	2.00	2.50	65.0	73.0	57.0
052366	6s-63s	M63x1.5	15	2/2 1/2	21/30	38.0	50.0	45.5	60.5	130.0	2.00	2.50	80.0	90.0	66.0
052306	6-63	M63x1.5	15	2/2 1/2	21/30	44.0	56.5	52.5	65.5	130.0	2.00	2.50	80.0	90.0	66.0
052377	7s-75s	M75x1.5	15	2 1/2/3	30/32	50.0	62.0	57.0	72.5	138.0	2.50	3.15	96.0	108.0	72.0
052307	7-75	M75x1.5	15	2 1/2/3	30/32	56.0	67.5	65.5	78.0	138.0	2.50	3.15	96.0	108.0	72.0
052308	8-80	M80x2.0	20	3	32	59.0	69.0	65.0	77.5	195.0	2.50	3.15	96.0	108.0	80.0
052399	9s-90s	M90x2.0	20	3/3 1/2	32/33	66.0	75.0	73.0	86.5	204.0	3.00	3.50	111.0	125.0	89.0
052309	9-90	M90x2.0	20	3/3 1/2	32/33	74.0	81.5	82.0	91.0	204.0	3.00	3.50	111.0	125.0	89.0
052310	10-100	M100x2.0	20	3 1/2/4	33/34	81.0	91.0	90.0	100.0	209.0	3.00	3.50	125.0	141.0	98.0
052311	11-115	M115x2.0	20	4	34	86.0	98.0	100.0	114.0	209.0	3.00	4.00	135.0	152.0	175.0
052312	12-120	M120x2.0	20	-	-	96.0	103.0	103.0	118.0	209.0	3.00	4.00	140.0	158.0	175.0
052313	13-130	M130x2.0	20	-	-	100.0	115.0	113.0	124.0	209.0	3.00	4.00	146.0	164.0	175.0

All dimensions except NPT are in mm. Intermediate thread sizes are available on request. NPT threads should be tightened 'wrench tight'.

CCG reserves the right to make alterations to the technical data, dimensions, designs and products available without notice. The illustrations cannot be considered binding. Please contact CCG for assistance.

E1EX-GH011121E

# E1EX GLAND Ex db IIC, Ex eb IIC, Ex tb IIC, Ex nR IIC

### ENCLOSURES AND EQUIPMENT TO WHICH CABLE GLANDS ARE FITTED:-

- Must be made from materials which are compatible with the cable gland materials.
- Have a sealing area around the cable gland entry point with a surface roughness <math>< Ra 6.3 \mu m</math>.
- Have entries that are perpendicular to the enclosure face in the area where the cable gland will seal to within 2.5°.
- Are sealed using the supplied sealing gasket (parallel threads) or by fully tightening into a threaded entry (tapered threads). Note that for tapered threads the IP rating can be improved to IP68 with the use of a suitable thread sealant.

### MUST HAVE THREADED ENTRIES

- The same thread size as the cable gland. (Thread adapters should be used to correct

any mismatch).

- With a thread tolerance of metric class '6H' or equivalent.
- Where the thread length is a minimum of 10mm for Ex d applications or 3mm for all other applications

### OR CLEARANCE HOLES (not Ex d)

- Where the hole size is the thread nominal size with a tolerance of +0.1 to +0.7mm. (e.g. the clearance hole for an M20 thread will have a diameter between 20.1mm and 20.7mm).
- Through material that is between 1mm and 12mm thick. (Thicker materials can be accommodated using glands with extended entry threads.)

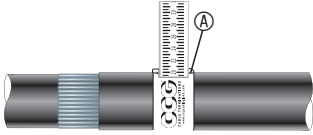

1. For accurate sizing, use a CCG Dimension Tape (A) on the inner and outer cable sheath.

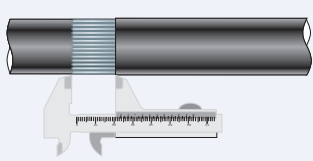

Gland Size	Armour Length	Gland Size	Armour Length	Gland Size	Armour Length	Gland Size	Armour Length
00-16ss	20.0	3s-32s	30.0	6s-63s	45.0	9-90	50.0
00-20ss	20.0	3-32	30.0	6-63	45.0	10-100	60.0
0-20s	20.0	4s-40s	30.0	7s-75s	50.0	11-115	60.0
1-20	25.0	4-40	30.0	7-75	50.0	12-120	60.0
2s-25s	25.0	5s-50s	35.0	8-80	50.0	13-130	60.0
2-25	25.0	5-50	35.0	9s-90s	50.0		

2. Cut back the cable outer sheath to expose the armour to a length as per the table above.

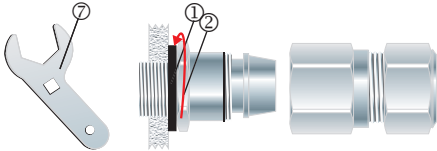

3. To maintain IP66/68 ensure the gasket (1) is in place. Screw the inner (2) into the apparatus. Tighten the inner (2) to the installation torque using a CCG Spanner (7).

Alternative installation through an unthreaded entry.

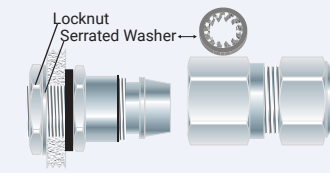

If the apparatus is untapped use a locknut.

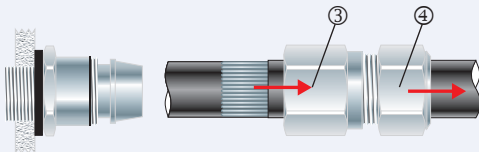

4. Pass the outer nut (4) and the body (3) over the cable.

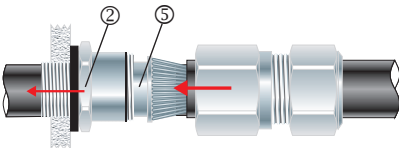

5. Pass the cable end through the inner (2). Splay the armour wires over the cone (5).

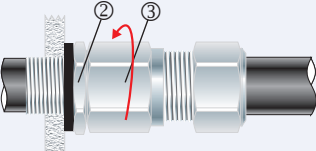

6. Tighten the body (3) onto the inner (2) until hand tight, then tighten with a CCG Spanner (7) with 3/4 turn to lock the armour between the cone (5) and the cone ring (6).

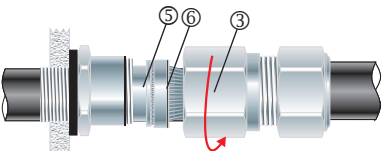

7. Unscrew the body (3). Check that the armour has locked between the cone (5) and cone ring (6). (O-Ring on the cone ring (6) is sacrificial).

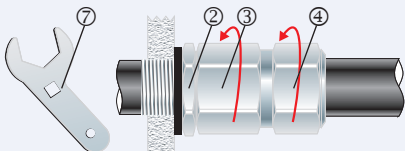

8. Tighten the body (3) onto the inner (2) to the installation torque using a CCG Spanner (7). The Variable Deluge Seal™ will engage automatically as the body is tightened onto the inner (2). Tighten the outer nut (4) to produce a moisture proof seal by turning until the seal makes contact with the outer sheath of cable and then make one full turn.

YouTube Instruction Video: <http://youtu.be/Lw-LxOyyoV0>