

E1EX-U-VS

Ex db I/ IIC, Ex eb I/IIC, Ex tb IIIC, Ex nR IIC

CAPTIVE COMPONENT GLAND™ Multi Armoured Copper Tape or Lead Sheathed Cable

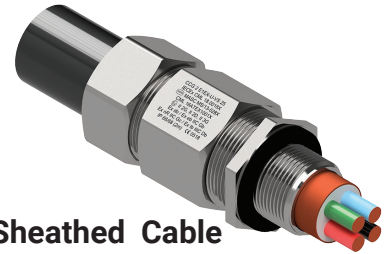

Features and Benefits

- For indoors, outdoors, Group I, II, III, Zone 1, 2, 21 and 22 hazardous areas.
- Two part handling, no loose parts.
- Freely rotating captive cone and inspectible cone ring an armour clamp and earth bond for steel wire, aluminium, braid and tape armour.
- Patented disconnect system that allows inspection of armour clamp and inner seal after assembly.
- Provides 360° earthing to copper tape or lead sheath.
- Factory fitted captive elastomeric seals for Built-in Safety™. Seals on both inner and outer sheaths to IP65/66/68.
- Precision manufactured from high-quality brass (Marine Grade Electroless Nickel Plated™) available in stainless steel 316/316L on request.
- Complete with thread sealing gasket and an end cap safety gauge for correct gland selection.



Technical Data

Type:	E1EX-U-VS
Gland Material:	Brass (Marine Grade Electroless Nickel Plated™), Stainless Steel 316/316L
Seal Material:	Standard Thermoset Elastomer or Extreme Temperature Seals
Seal Gasket Material:	HDPE, Nylon 66 or PTFE
Cable Type:	Steel Wire, Aluminium, Braided, Tape Armour and Copper Tape used for VSD (Variable Speed Drives) or Lead sheathed
Armour Clamping:	Rotating Captive Cone and Inspectible Cone Ring
Sealing Area:	Inner Sheath and Outer Sheath
Optional Accessories:	Adaptor, Reducer, Earth Tag, Locknut, Serrated Washer and Shroud
Note:	The installer should ensure that the materials are suitable for the installation environment.

Standards and Certifications

Equipment Protection Levels:	IECEX: Ex d I Mb/ IIC Gb, Ex e I Mb/IIC Gb, Ex nR IIC Gc, Ex tb IIIC Db ATEX: Ⓢ I M2, II 2 GD, II 3G, Ex db I Mb/ IIC Gb, Ex eb I Mb/IIC Gb, Ex nR IIC Gc, Ex tb IIIC Db TR CU: 1Ex d IIC Gb X / PB Ex d I Mb X / 1Ex e IIC Gb X / PT Ex e I Mc X / 2Ex nR IIC Gc X / Ex tb IIIC Db X	
Continuous Operating Temp:	Standard Seals: -60°C to +95°C/100°C (HDPE/Nylon Sealing Gasket) Extreme Temp. Seals: -60°C to +160°C (PTFE)	
Conformance:	Standard:	Certificate:
IEC/BS EN	IEC/BS EN 62444	CML 14CA364
IECEX	IEC 60079 Parts 0, 1, 7, 15, 31	IECEX ITA 12.0014X
ATEX	EN 60079 Parts 0, 1, 7, 31 EN 60079 Parts 0, 15	CML 16ATEX1001X CML 16ATEX4002X
INMETRO (Brazil)	ABNT NBR IEC 60079 Parts 0, 1, 7, 15, 31	TÜV 15.0483X
IP66/68 100m - Parallel	IEC 60529	CML 15Y728
IP65/66 - Tapered	IEC 60529	
Corrosion Protection	ASTM B117-11, BS EN ISO 3231	EXOVA N968667
Marine ABS	IEC/EN 60079 Parts 0, 1, 7, 15, 31	ABS 20-SG1952706-PDA
EMC Compatible	EN 55011:2009 + A1:2010, EN 55022:2010	SGS EMC197708/1



Conditions for Safe Use - X

- The cable glands shall only be used where the temperature, at the point of entry, is between -60°C and +95°C (standard seal & HDPE sealing gasket), +100°C (standard seal and Nylon sealing gasket) or +160°C (extreme temp. seal & PTFE sealing gasket) depending on seal and gasket used.
- Braided cables are only suitable for Group II or III applications with this gland and the user shall ensure adequate clamping of the cable.
- According to IEC 60079-14, 10.6.2: An Ex d gland will only maintain Ex d integrity when used with substantially round, compact and filled cable. If not a CCG QuickStop-Ex® barrier gland should be used.

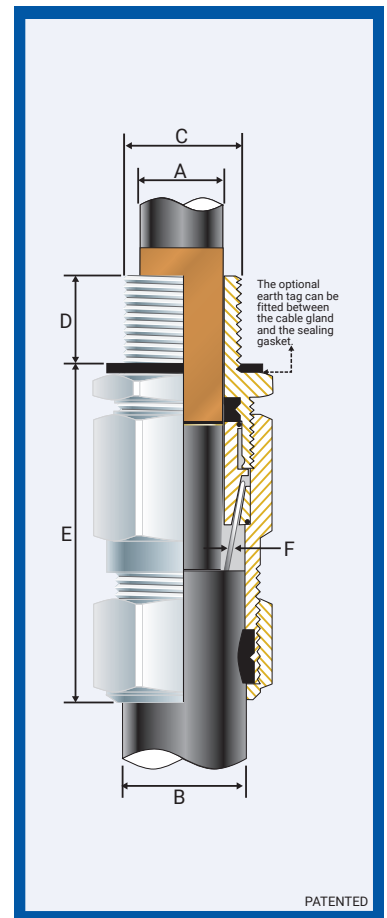

Product Code	Gland Size Reference	Metric Entry Thread		NPT Entry Thread		Cable Detail				Max Length 'E'	Armour Dia		Hexagonal Detail		Install. Torque Value Nm
		'C'	Min 'D'	'C'	Min 'D'	Min 'A'	Max 'A'	Min 'B'	Max 'B'		Min 'F'	Max 'F'	Max 'Flats'	Max 'Crns'	
058500-16	00s-16ss	M16x1.5	15	-	15	3.0	8.5	5.0	10.5	60.0	0.20	0.90	25/27	28/30	21.0
058500S	00s-20ss	M20x1.5	15	1/2 3/4	15	3.0	8.5	5.0	10.5	60.0	0.20	0.90	25/27	28/30	21.0
058500	00-20ss	M20x1.5	15	1/2 3/4	15	3.0	8.5	8.0	13.5	60.0	0.20	0.90	25/27	28/30	21.0
0585-0S	0s-20s	M20x1.5	15	1/2 3/4	15	7.0	12.0	8.0	13.5	60.0	0.20	1.25	25/27	28/30	21.0
0585-0	0-20s	M20x1.5	15	1/2 3/4	15	7.0	12.0	11.5	16.0	60.0	0.20	1.25	25/27	28/30	21.0
058501	1-20	M20x1.5	15	1/2 3/4	15	9.0	15.0	12.5	20.5	73.0	0.20	1.25	30	34	21.0
058522	2s-25s	M25x1.5	15	3/4 1	15/19	11.0	17.5	16.0	24.5	82.4	0.20	1.60	38	43	30.0
058502	2-25	M25x1.5	15	3/4 1	15/19	14.0	20.0	18.0	27.0	82.0	0.20	1.60	38	43	30.0
058533	3s-32s	M32x1.5	15	1 1/4	19	15.0	22.0	20.0	30.5	91.0	0.20	2.00	45	51	42.0
058503	3-32	M32x1.5	15	1 1/4	19	19.0	26.5	23.0	33.5	91.0	0.20	2.00	45	51	42.0
058544	4s-40s	M40x1.5	15	1 1/4 1 1/2	19/21	22.0	31.5	26.5	39.5	105.0	0.30	2.00	55	62	52.0
058504	4-40	M40x1.5	15	1 1/4 1 1/2	19/21	26.0	34.0	28.0	40.0	105.0	0.30	2.00	55	62	52.0
058555	5s-50s	M50x1.5	15	1 1/2 2	21	29.0	38.0	35.2	46.7	123.0	0.40	2.50	65	73	57.0
058505	5-50	M50x1.5	15	1 1/2 2	21	34.0	44.5	44.4	53.0	123.0	0.40	2.50	65	73	57.0
058566	6s-63s	M63x1.5	15	2 1/2 3	21/30	38.0	50.0	45.5	59.4	147.0	0.40	2.50	85	96	66.0
058506	6-63	M63x1.5	15	2 1/2 3	21/30	44.0	56.5	54.6	65.9	147.0	0.40	2.50	85	96	66.0
058577	7s-75s	M75x1.5	15	2 1/2 3	30/32	50.0	62.0	59.0	72.5	149.0	0.40	3.15	96	108	72.0
058507	7-75	M75x1.5	15	2 1/2 3	30/32	56.0	67.5	65.0	78.0	149.0	0.40	3.15	96	108	72.0
058508	8-80	M80x2.0	20	3	32	59.0	69.0	65.0	77.5	195.0	0.40	3.15	96	108	80.0
058599	9s-90s	M90x2.0	20	3 3/4	32/33	66.0	75.0	73.0	86.5	204.0	0.40	3.50	111	125	89.0
058509	9-90	M90x2.0	20	3 3/4	32/33	74.0	81.5	82.0	91.0	204.0	0.40	3.50	111	125	89.0
058510	10-100	M100x2.0	20	3 3/4 4	33/34	81.0	91.0	90.0	100.0	209.0	0.40	3.50	125	141	98.0

All dimensions except NPT are in mm. Intermediate thread sizes are available on request.

CCG reserves the right to make alterations to the technical data, dimensions, designs and products available without notice. The illustrations cannot be considered binding. Please contact CCG for assistance. E1EXUVS-HMG210520E

E1EX-U-VS GLAND Ex db I/ IIC, Ex eb I/IIC, Ex tb IIIC, Ex nR IIC

ENCLOSURES AND EQUIPMENT TO WHICH CABLE GLANDS ARE FITTED:-

- Must be made from materials which are compatible with the cable gland materials.
- Have a sealing area around the cable gland entry point with a surface roughness <math>< Ra 6.3 \mu m</math>.
- Have entries that are perpendicular to the enclosure face in the area where the cable gland will seal to within 2.5°.
- Are sealed using the supplied sealing gasket (parallel threads) or by fully tightening into a threaded entry (tapered threads). Note that for tapered threads the IP rating can be improved to IP68 with the use of a suitable thread sealant.

MUST HAVE THREADED ENTRIES

- The same thread size as the cable gland. (Thread adapters should be used to correct

any mismatch).

- With a thread tolerance of metric class '6H' or equivalent.
- Where the thread length is a minimum of 10mm for Ex d applications or 3mm for all other applications

OR CLEARANCE HOLES (not Ex d)

- Where the hole size is the thread nominal size with a tolerance of +0.1 to +0.7mm. (e.g. the clearance hole for an M20 thread will have a diameter between 20.1mm and 20.7mm).
- Through material that is between 1mm and 12mm thick. (Thicker materials can be accommodated using glands with extended entry threads.)

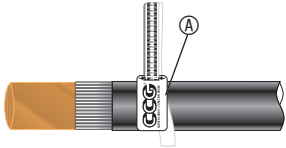

1. For accurate sizing, use a CCG Dimension Tape (A) on the inner and outer cable sheath.

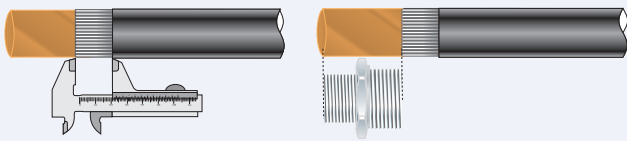

Gland Size	Armour Length	Gland Size	Armour Length	Gland Size	Armour Length	Gland Size	Armour Length
00-16ss	20.0	3s-32s	30.0	6s-63s	45.0	9-90	50.0
00-20ss	20.0	3-32	30.0	6-63	45.0	10-100	60.0
0-20s	20.0	4s-40s	30.0	7s-75s	50.0	11-115	60.0
1-20	25.0	4-40	30.0	7-75	50.0	12-120	60.0
2s-25s	25.0	5s-50s	35.0	8-80	50.0	13-130	60.0
2-25	25.0	5-50	35.0	9s-90s	50.0		

2. Cut back the cable outer sheath to expose the armour to a length as per the table above. Cut the PVC sheath exposing the copper tape to the length of the inner (2).

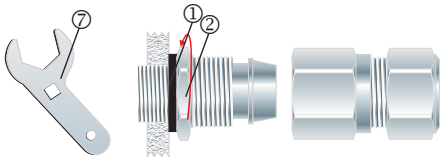

3. To maintain IP66/68 ensure the gasket (1) is in place. Screw the inner (2) into the apparatus. Tighten the inner (2) to the installation torque using a CCG Spanner (7).

Alternative installation through an unthreaded entry.

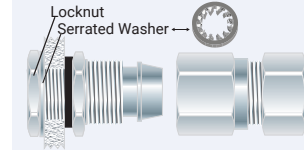

If the apparatus is untapped use a locknut.

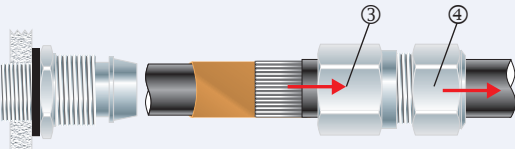

4. Pass the outer nut (3) and the body (4) over the cable.

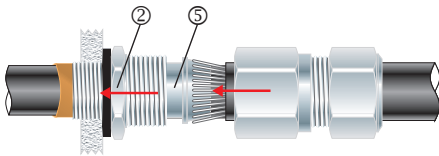

5. Pass the cable end through the inner (2) ensure the copper tape does not unravel. Splay the armour wires over the cone (5).

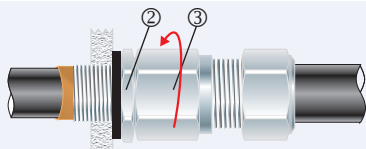

6. Tighten the body (3) onto the inner (2) to lock the armour between the cone (5) and cone ring (6).

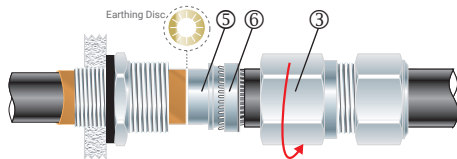

7. Unscrew the body (3). Check that the armour has locked between the cone (5) and cone ring (6). (O-Ring on the cone ring (6) is sacrificial). Check the copper tape has passed through and makes 360° contact with the earthing disc.

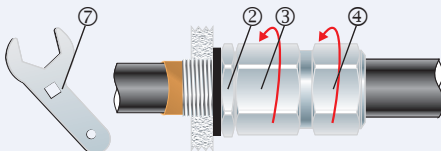

8. Tighten the body (3) onto the inner (2) to the installation torque using a CCG Spanner (7). Tighten the outer nut (4) to produce a moisture proof seal by turning until the seal makes contact with the outer sheath of cable and then make one full turn.

YouTube Instruction Video: <http://youtu.be/Lw-LxOyyoV0>